

# MODIFICATION HISTORY (1/2)

MODEL NAME :  
HMD-A200/HMD-A220  
 SERVICE MANUAL  
 PARTS No. : 9-978-661-07

\* Blue characters are linking.

# No.	DATA	CONTENTS
#1	<del>2000.2</del>	<del>Adds omitted parts numbers. (P.7-1, 7-2, 7-3, 7-4, 7-5, 7-6, 7-7, 7-8, 7-9, 7-10, 59)</del>
#2	2000.2	Alteration of parts supply, as the service division had changed. (P.6-1, 6-2)
#3	<del>2000.3</del>	<del>Decide on part number (IC901 on D board). (P.7-7)</del>
#4	<del>2000.3</del>	<del>Parts number clerical error correction (C625 on D board). (P.7-4)</del>
#5	2000.5	Add omitted part (LABEL, INFORMATION). (P.6-1)
#6	2000.8	Because a VAIO color model was added, ten parts were added to the Exploded Views. (P.6-1, 6-2)
#7	<del>2000.11</del>	<del>Parts number clerical error correction (Q517, Q5H1 on D board). (P.7-7)</del>
#8	2000.11	Correction and modification due to addition of model name. (HMD-A220) (P.6-1, 6-2)
#9	2000.12	Parts number clerical error correction. (P.5-11, 5-12, 5-15, 5-16, 5-17, 5-18, 5-19, 5-20, 6-2, 7-1, 7-3, 7-4, 7-5, 7-6, 7-7, 7-8, 7-9)
#10	2001.3	Parts number clerical error correction. BEZEL ASSY(HMD-A220) X-4038-204-1 → X-4038-207-1 (P.6-1)
#11	2001.3	Part numbers of BEZEL ASSY for J destination were registered as usual, and those for U/C destination were newly registered. BEZEL ASSY(VAIO color) J: X-4038-448-1[With VAIO logo] U/C: X-4039-027-1[Without VAIO logo] (P.6-1)
#12	<del>2001.3</del>	<del>Parts number clerical error correction (FB013 on A board). (P.7-2)</del>



# HMD-A200/HMD-A220

## SERVICE MANUAL

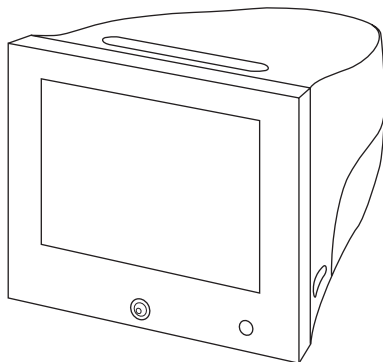

HMD-A200

*US Model*

*Canadian Model*

*AEP Model*

*Chassis No. SCC-L27N-A*

HMD-A220

*AEP Model*

*Chassis No. SCC-L27Q-A*

## X11R CHASSIS

### SPECIFICATIONS

CRT	0.24 mm aperture grille pitch 17 inches measured diagonally 90-degree deflection
Viewable image size	Approx. 327 × 243 mm (w/h) (12 <sup>7</sup> / <sub>8</sub> × 9 <sup>5</sup> / <sub>8</sub> inches) 16.0" viewing image
Resolution	Horizontal: Max. 1280 dots Vertical: Max. 1024 lines
Standard image area	Approx. 312 × 234 mm (w/h) (12 <sup>3</sup> / <sub>8</sub> × 9 <sup>1</sup> / <sub>4</sub> inches)
Deflection frequency*	Horizontal: 30 to 70 kHz Vertical: 48 to 120 Hz
AC input voltage/current	100 to 240 V, 50 – 60 Hz, 2.0 – 0.9 A
Power consumption	Max. 115 W (with no USB devices connected)
Operating temperature	10°C to 40°C
Dimensions	Approx. 460 × 378 × 441 mm (w/h/d) (18 <sup>1</sup> / <sub>8</sub> × 15 × 17 <sup>3</sup> / <sub>8</sub> inches)
Mass	Approx. 19 kg (41 lb 14 oz)
Plug and Play	DDC1/DDC2B
Supplied accessories	Power cord (1) USB cable (1) Windows Monitor Information Disk (1) Monitor stand (1) Warranty card (1) Notes on cleaning the screen's surface (1) This instruction manual (1)

- \* Recommended horizontal and vertical timing condition
- Horizontal sync width should be more than 1.0 μsec.
  - Horizontal blanking width should be more than 3.0 μsec.
  - Vertical blanking width should be more than 500 μsec.

Design and specifications are subject to change without notice.



TRINITRON® COLOR COMPUTER DISPLAY  
**SONY®**

**DIAGNOSIS**

Failure	Power LED
HV or +B Failure or H Stop	Blink Amber (On 0.5 sec, Off 0.5 sec)
V Stop	Blink Amber (On 1.5 sec, Off 0.5 sec)
ABL Failure	Blink Amber (On 0.5 sec, Off 1.5 sec)
Aging/Self-Test	Blink Amber (On 0.5 sec, Off 0.5 sec) .... Blink Green (On 0.5 sec, Off 0.5 sec)

**TIMING SPECIFICATION**

PRIMARY MODE MODE AT PRODUCTION	MODE 1	MODE 2	MODE 3	MODE 4	MODE 5	MODE 6	MODE 7	MODE 8	MODE 9
RESOLUTION	640 X 480	640 X 480	720 X 400	800 X 600	800 X 600	832 X 624	1024 X 768	1024 X 768	1280 X 1024
CLOCK	25.175 MHz	36.000 MHz	28.322 MHz	49.500 MHz	56.250 MHz	57.283 MHz	78.750 MHz	94.500 MHz	108.000 MHz
— HORIZONTAL —									
H-FREQ	31.469 kHz	43.269 kHz	31.469 kHz	46.875 kHz	53.674 kHz	49.725 kHz	60.024 kHz	68.677 kHz	63.981 kHz
	usec	usec	usec	usec	usec	usec	usec	usec	usec
H. TOTAL	31.778	23.111	31.777	21.333	18.631	20.111	16.660	14.561	15.630
H. BLK	6.356	5.333	6.355	5.172	4.409	5.586	3.657	3.725	3.778
H. FP	0.636	1.556	0.636	0.323	0.569	0.559	0.203	0.508	0.444
H. SYNC	3.813	1.556	3.813	1.616	1.138	1.117	1.219	1.016	1.037
H. BP	1.907	2.222	1.907	3.232	2.702	3.910	2.235	2.201	2.296
H. ACTIV	25.422	17.778	25.422	16.162	14.222	14.524	13.003	10.836	11.852
— VERTICAL —									
V. FREQ(HZ)	59.940 Hz	85.008 Hz	70.087 Hz	75.000 Hz	85.061 Hz	74.550 Hz	75.030 Hz	84.997 Hz	60.020 Hz
	lines	lines	lines	lines	lines	lines	lines	lines	lines
V. TOTAL	525	509	449	625	631	667	800	808	1066
V. BLK	45	29	49	25	31	43	32	40	42
V. FP	10	1	12	1	1	1	1	1	1
V. SYNC	2	3	2	3	3	3	3	3	3
V. BP	33	25	35	21	27	39	28	36	38
V. ACTIV	480	480	400	600	600	624	768	768	1024
— SYNC —									
INT(G)	NO	NO	NO	NO	NO	NO	NO	NO	NO
EXT(H/V)/POLARITY	YES -/-	YES -/-	YES -/+	YES +/+	YES +/+	YES -/-	YES +/+	YES +/+	YES +/+
EXT(CS)/POLARITY	NO	NO	NO	NO	NO	NO	NO	NO	NO
INT/NON INT	NON INT	NON INT	NON INT	NON INT	NON INT	NON INT	NON INT	NON INT	NON INT

99.7.2 VER.

**Power saving function**

This monitor meets the power-saving guidelines set by VESA, ENERGY STAR, and NUTEK. If the monitor is connected to a computer or video graphics board that is DPMS (Display Power Management Signaling) compliant, the monitor will automatically reduce power consumption in three stages as shown right.

\* Figures reflect power consumption when no USB compatible peripherals are connected to the monitor.

\*\*When your computer enters the "active off" mode, the input signal is cut and NO INPUT SIGNAL appears on the screen. After 20 seconds, the monitor enters the power saving mode.

Power mode	Power consumption*	⏻ (power) indicator
normal operation	≤ 115 W	green
1 standby	≤ 15 W	green and orange alternate
2 suspend	≤ 15 W	green and orange alternate
3 active off**	≤ 5 W	orange
power off	0 W	off

## SAFETY CHECK-OUT

After correcting the original service problem, perform the following safety checks before releasing the set to the customer:

1. Check the area of your repair for unsoldered or poorly-soldered connections. Check the entire board surface for solder splashes and bridges.
2. Check the interboard wiring to ensure that no wires are “pinched” or contact high-wattage resistors.
3. Check that all control knobs, shields, covers, ground straps, and mounting hardware have been replaced. Be absolutely certain that you have replaced all the insulators.
4. Look for unauthorized replacement parts, particularly transistors, that were installed during a previous repair. Point them out to the customer and recommend their replacement.
5. Look for parts which, though functioning, show obvious signs of deterioration. Point them out to the customer and recommend their replacement.
6. Check the line cords for cracks and abrasion. Recommend the replacement of any such line cord to the customer.
7. Check the B+ and HV to see if they are specified values. Make sure your instruments are accurate; be suspicious of your HV meter if sets always have low HV.
8. Check the antenna terminals, metal trim, “metallized” knobs, screws, and all other exposed metal parts for AC Leakage. Check leakage as described below.

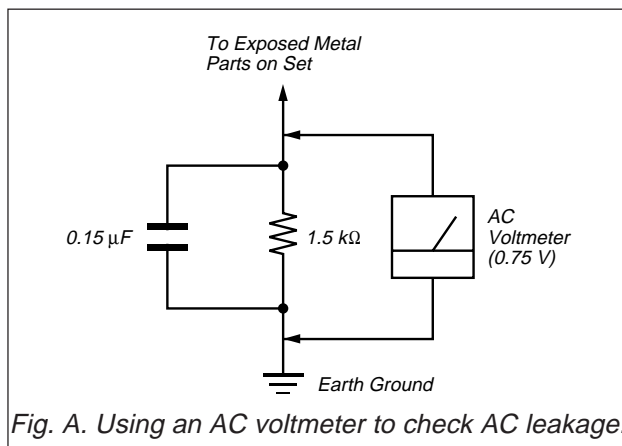

Fig. A. Using an AC voltmeter to check AC leakage.

## LEAKAGE TEST

The AC leakage from any exposed metal part to earth ground and from all exposed metal parts to any exposed metal part having a return to chassis, must not exceed 0.5 mA (500 microamperes).

Leakage current can be measured by any one of three methods.

1. A commercial leakage tester, such as the Simpson 229 or RCA WT-540A. Follow the manufacturers' instructions to use these instruments.
2. A battery-operated AC milliammeter. The Data Precision 245 digital multimeter is suitable for this job.
3. Measuring the voltage drop across a resistor by means of a VOM or battery-operated AC voltmeter. The “limit” indication is 0.75 V, so analog meters must have an accurate low-voltage scale. The Simpson 250 and Sanwa SH-63Trd are examples of a passive VOMs that are suitable. Nearly all battery operated digital multimeters that have a 2 V AC range are suitable. (See Fig. A)

**WARNING!!**

**NEVER TURN ON THE POWER IN A CONDITION IN WHICH THE DEGAUSS COIL HAS BEEN REMOVED.**

**SAFETY-RELATED COMPONENT WARNING!!**  
**COMPONENTS IDENTIFIED BY SHADING AND MARK  $\triangle$  ON THE SCHEMATIC DIAGRAMS, EXPLODED VIEWS AND IN THE PARTS LIST ARE CRITICAL FOR SAFE OPERATION. REPLACE THESE COMPONENTS WITH SONY PARTS WHOSE PART NUMBERS APPEAR AS SHOWN IN THIS MANUAL OR IN SUPPLEMENTS PUBLISHED BY SONY. CIRCUIT ADJUSTMENTS THAT ARE CRITICAL FOR SAFE OPERATION ARE IDENTIFIED IN THIS MANUAL. FOLLOW THESE PROCEDURES WHENEVER CRITICAL COMPONENTS ARE REPLACED OR IMPROPER OPERATION IS SUSPECTED.**

**AVERTISSEMENT!!**

**NE JAMAIS METTRE SOUS TENSION QUAND LA BOBINE DE DEMAGNETISATION EST ENLEVÉE.**

**ATTENTION AUX COMPOSANTS RELATIFS À LA SÉCURITÉ!!**

**LES COMPOSANTS IDENTIFIÉS PAR UNE TRAME ET UNE MARQUE  $\triangle$  SONT CRITIQUES POUR LA SÉCURITÉ. NE LES REMPLACER QUE PAR UNE PIÈCE PORTANT LE NUMÉRO SPECIFIÉ. LES RÉGLAGES DE CIRCUIT DONT L'IMPORTANCE EST CRITIQUE POUR LA SÉCURITÉ DU FONCTIONNEMENT SONT IDENTIFIÉS DANS LE PRÉSENT MANUEL. SUIVRE CES PROCÉDURES LORS DE CHAQUE REMPLACEMENT DE COMPOSANTS CRITIQUES, OU LORSQU'UN MAUVAIS FONCTIONNEMENT EST SUSPECTÉ.**

## TABLE OF CONTENTS

<i>Section</i>	<i>Title</i>	<i>Page</i>
<b>1. GENERAL</b>		1-1
<b>2. DISASSEMBLY</b>		
2-1.	Bucket Removal	2-1
2-2.	A, D, U1 and U2 Boards Removal	2-1
2-3.	H Board Removal	2-1
2-4.	Picture Tube Removal	2-2
2-5.	Harnes Location	2-3
<b>3. SAFETY RELATED ADJUSTMENT</b>		3-1
<b>4. ADJUSTMENTS</b>		4-1
<b>5. DIAGRAMS</b>		
5-1.	Block Diagrams	5-1
5-2.	Circuit Boards Location	5-7
5-3.	Schematic Diagrams and Printed Wiring Boards	5-8
(1)	Schematic Diagrams of U1 and U2 Boards	5-9
(2)	Schematic Diagram of A Board	5-11
(3)	Schematic Diagram of D Board	5-15
(4)	Schematic Diagram of H Board	5-25
5-4.	Semiconductors	5-27
<b>6. EXPLODED VIEWS</b>		
6-1.	Chassis	6-1
6-2.	Packing Materials	6-2
<b>7. ELECTRICAL PARTS LIST</b>		7-1

# SECTION 1 GENERAL

The operating instructions mentioned here are partial abstracts from the Operating Instruction Manual. The page numbers of the Operating Instruction Manual remain as in the manual.

## Precautions

### Warning on power connections

- Use the supplied power cord. If you use a different power cord, be sure that it is compatible with your local power supply.

#### For the customers in the UK

If you use the monitor in the UK, be sure to use the supplied UK power cable.

Example of plug types

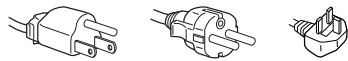

for 100 to 120 V AC    for 200 to 240 V AC    for 240 V AC only

- Before disconnecting the power cord, wait at least 30 seconds after turning off the power to allow the static electricity on the screen's surface to discharge.
- After the power is turned on, the screen is demagnetized (degaussed) for about 5 seconds. This generates a strong magnetic field around the screen which may affect data stored on magnetic tapes and disks placed near the monitor. Be sure to keep magnetic recording equipment, tapes, and disks away from the monitor.

The equipment should be installed near an easily accessible outlet.

### Installation

Do not install the monitor in the following places:

- on surfaces (rugs, blankets, etc.) or near materials (curtains, draperies, etc.) that may block the ventilation holes
- near heat sources such as radiators or air ducts, or in a place subject to direct sunlight
- in a place subject to severe temperature changes
- in a place subject to mechanical vibration or shock
- on an unstable surface
- near equipment which generates magnetism, such as a transformer or high voltage power lines
- near or on an electrically charged metal surface

### Maintenance

- Clean the screen with a soft cloth. If you use a glass cleaning liquid, do not use any type of cleaner containing an anti-static solution or similar additive as this may scratch the screen's coating.
- Do not rub, touch, or tap the surface of the screen with sharp or abrasive items such as a ballpoint pen or screwdriver. This type of contact may result in a scratched picture tube.
- Clean the cabinet, panel and controls with a soft cloth lightly moistened with a mild detergent solution. Do not use any type of abrasive pad, scouring powder or solvent, such as alcohol or benzene.

### Transportation

When you transport this monitor for repair or shipment, use the original carton and packing materials.

### Use of the stand

Insert the supplied stand into the groove to adjust the angle of the monitor. You can use the stand in either the vertical or horizontal position.

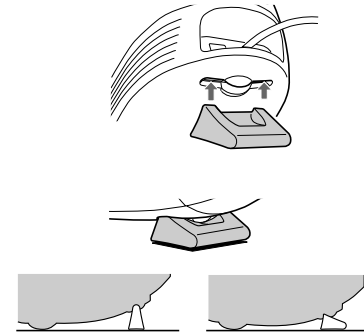

### Use of the groove on top (HMD-A200 only)

You can put a photo frame or CD case in the groove.

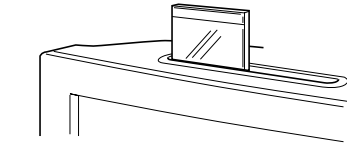

#### Note

Never use the slit for any other purpose.

### Use of the headphones' hook (HMD-A100 only)

Insert the supplied hook into one of the holes (ten on both the left and right sides) on either the left or right side of the monitor.

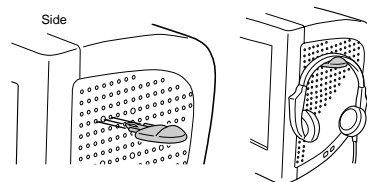

#### Note

Never hang heavy objects from the hook other than the headphones.

## Identifying parts and controls

See the pages in parentheses for further details. (Model HMD-A200 is used for illustration purposes.)

### Front

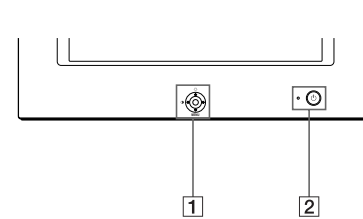

#### 1 Control button (page 9)

The control button is used to display the menu and make adjustments to the monitor, including brightness and contrast adjustments.

#### 2 (power) switch and indicator (pages 6, 13, 16)

This button turns the monitor on and off. The power indicator lights up in green when the monitor is turned on, and either flashes in green and orange, or lights up in orange when the monitor is in power saving mode.

#### 3 AC IN connector (page 6)

This connector provides AC power to the monitor.

### Rear

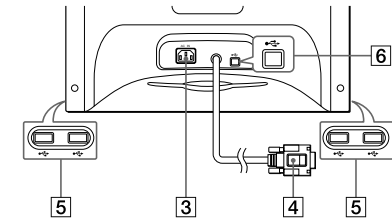

#### 4 Video input connector (HD15) (page 6)

This connector inputs RGB video signals (0.700 Vp-p, positive) and sync signals.

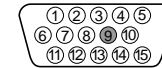

Pin No.	Signal
1	Red
2	Green (Composite Sync on Green)
3	Blue
4	ID (Ground)
5	DDC Ground*
6	Red Ground
7	Green Ground
8	Blue Ground
9	-
10	Ground
11	ID (Ground)
12	Bi-Directional Data (SDA)*
13	H. Sync
14	V. Sync
15	Data Clock (SCL)*

\* DDC (Display Data Channel) is a standard of VESA.

#### 5 USB (universal serial bus) downstream connectors (page 7)

Use these connectors to link USB peripheral devices to the monitor.

#### 6 USB (universal serial bus) upstream connector (page 7)

Use this connector to link the monitor to a USB compliant computer.

GB

## Setup

Before using your monitor, check that the following accessories are included in your carton:

- Power cord (1)
- USB cable (1)
- Windows Monitor Information Disk (1)
- Monitor stand (1)
- Hook (1) (HMD-A100 only)
- Warranty card (1)
- Notes on cleaning the screen's surface (1)
- This instruction manual (1)

### Step 1: Connect your monitor to your computer

Turn off the monitor and computer before connecting.

#### ■ Connecting to an IBM PC/AT or compatible computer

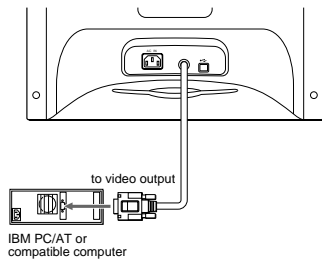

#### ■ Connecting to a Macintosh or compatible computer

You will need a Macintosh adapter (not supplied).

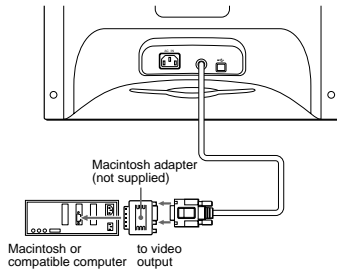

### Step 2: Connect the power cord

With the monitor and computer switched off, first connect the power cord to the monitor, then connect it to a power outlet.

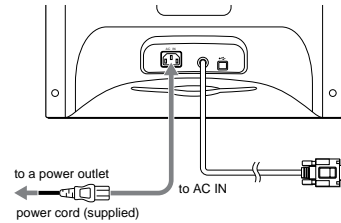

### Step 3: Turn on the monitor and computer

First turn on the monitor, then turn on the computer.



The installation of your monitor is complete. If necessary, use the monitor's controls to adjust the picture.

#### If no picture appears on your screen

- Check that the monitor is correctly connected to the computer.
- If NO INPUT SIGNAL appears on the screen, confirm that your computer's graphic board is completely seated in the correct bus slot.
- If you are replacing an old monitor with this model and OUT OF SCAN RANGE appears on the screen, reconnect the old monitor. Then adjust the computer's graphic board so that the horizontal frequency is between 30 – 70 kHz, and the vertical frequency is between 48 – 120 Hz.

For more information about the on-screen messages, see "Trouble symptoms and remedies" on page 14.

#### For customers using Windows 95/98

To maximize the potential of your monitor, install the new model information file from the supplied Windows Monitor Information Disk onto your PC.

This monitor complies with the "VESA DDC" Plug & Play standard. If your PC/graphics board complies with DDC, select "Plug & Play Monitor (VESA DDC)" or this monitor's model name as the monitor type in the "Control Panel" of Windows 95/98. If your PC/graphics board has difficulty communicating with this monitor, load the Windows Monitor Information Disk and select this monitor's model name as the monitor type.

#### For customers using Windows NT4.0

Monitor setup in Windows NT4.0 is different from Windows 95/98 and does not involve the selection of monitor type. Refer to the Windows NT4.0 instruction manual for further details on adjusting the resolution, refresh rate, and number of colors.

#### Adjusting the monitor's resolution and color number

Adjust the monitor's resolution and color number by referring to your computer's instruction manual. The color number may vary according to your computer or video board. The color palette setting and the actual number of colors are as follows:

- High Color (16 bit) → 65,536 colors
  - True Color (24 bit) → about 16.77 million colors
- In true color mode (24 bit), speed may be slower.

## Connecting Universal Serial Bus (USB) compliant peripherals

Your monitor has one upstream USB connector (on the rear panel) and four downstream USB connectors (two on both the left and right sides). They provide a fast and easy way to connect USB compliant peripheral devices (such as keyboards, mice, printers and scanners) to your computer using a standardized USB cable. To use your monitor as a hub for your peripheral devices, connect the USBs as illustrated below.

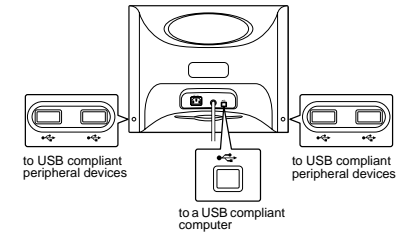

#### 1 Turn on the monitor and computer.

#### 2 Connect your computer to the square upstream USB connector using the supplied USB cable.

#### For customers using Windows

If a message appears on your screen, follow the on-screen instructions and select Generic USB Hub as the default setting.

#### 3 Connect your USB compliant peripheral devices to the rectangular downstream USB connectors.

#### Notes

- Not all computers and/or operating systems support USB configurations. Check your computer's instruction manual to see if you can connect USB devices.
- In most cases, USB driver software needs to be installed on the host computer. Refer to the peripheral device's instruction manual for further details.
- The monitor functions as a USB hub as long as the monitor is either "on" or in power saving mode.
- If you connect a keyboard or mouse to the USB connectors and then boot your computer for the first time, the peripheral devices may not function. First connect the keyboard and mouse directly to the computer and set up the USB compliant devices. Then connect them to this monitor.
- Do not lean on the monitor when plugging in the USB cables. The monitor may suddenly shift and cause injury.



## Selecting the on-screen menu language (LANGUAGE/INFORMATION)

English, French, German, Italian, Spanish, Russian, and Japanese versions of the on-screen menus are available. The default setting is English.

- 1 Press the center of the control button.  
See page 9 for more information on using the control button.

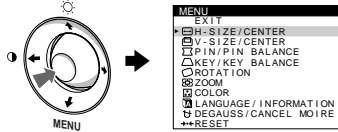

- 2 Move the control button to highlight LANGUAGE/INFORMATION and press the center of the control button again.

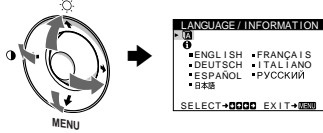

- 3 Move the control button ↓/↑ to select a language. Then move the control button ↓/↑ to select a language.

- ENGLISH
- FRANÇAIS: French
- DEUTSCH: German
- ITALIANO: Italian
- ESPAÑOL: Spanish
- РУССКИЙ: Russian
- 日本語: Japanese

### To close the menu

Press the center of the control button once to return to the main MENU, and twice to return to normal viewing. If no buttons are pressed, the menu closes automatically after about 30 seconds.

### To reset to English

See "Resetting the adjustments (RESET)" on page 12.

## Customizing Your Monitor

You can make numerous adjustments to your monitor using the on-screen menu.

### Navigating the menu

Press the center of the control button to display the main MENU on your screen. See page 9 for more information on using the control button.

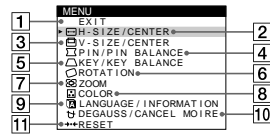
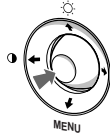

Use the control button to select one of the following menus.

#### 1] EXIT

Select EXIT to close the menu.

#### 2] H-SIZE/CENTER (page 10)

Select the H-SIZE/CENTER menu to adjust the picture's horizontal size and centering.

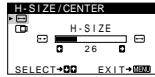

#### 3] V-SIZE/CENTER (page 10)

Select the V-SIZE/CENTER menu to adjust the picture's vertical size and centering.

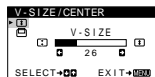

#### 4] PIN/PIN BALANCE (page 10)

Select the PIN/PIN BALANCE menu to adjust the curvature picture's sides.

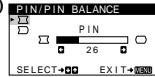

#### 5] KEY/KEY BALANCE (page 11)

Select the KEY/KEY BALANCE menu to adjust the angle of the picture's sides.

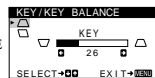

#### 6] ROTATION (page 11)

Select the ROTATION menu to adjust the picture's rotation.

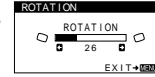

#### 7] ZOOM (page 11)

Select the ZOOM menu to enlarge or reduce the picture.

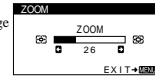

#### 8] COLOR (page 11)

Select the COLOR menu to adjust the picture's color temperature. You can use this to match the monitor's colors to a printed picture's colors.

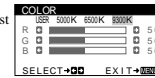

#### 9] LANGUAGE/INFORMATION (page 8, 15)

Select the LANGUAGE/INFORMATION menu to choose the on-screen menu's language and display this monitor's information box.



#### 10] DEGAUSS/CANCEL MOIRE (page 12)

Select the DEGAUSS/CANCEL MOIRE menu to degauss the screen and cancel the moire.

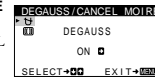

#### 11] RESET (page 12)

Select the RESET menu to reset the adjustments.

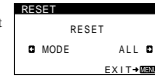

### ■ Displaying the current input signal

The horizontal and vertical frequencies of the current input signal are displayed in the BRIGHTNESS/CONTRAST menu. If the signal matches one of this monitor's factory preset modes, the resolution is also displayed.

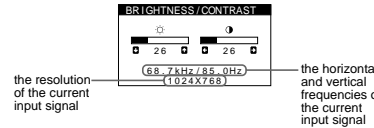

the resolution of the current input signal

the horizontal and vertical frequencies of the current input signal

### ■ Using the control button

#### 1] Display the main MENU.

Press the center of the control button to display the main MENU on your screen.

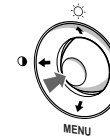

#### 2] Select the menu you want to adjust.

Highlight the desired menu by moving the control button up (↑), down (↓), and left (←) or right (→) to move sideways.

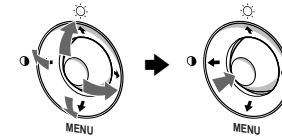

#### 3] Adjust the menu.

Move the control button left (←) or right (→) to make the adjustment.

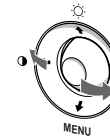

#### 4] Close the menu.

Press the center of the control button once to return to the main MENU, and twice to return to normal viewing. If no buttons are pressed, the menu closes automatically after about 30 seconds.

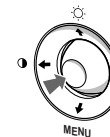

### ■ Resetting the adjustments

You can reset the adjustments using the RESET menu. See page 12 for more information on resetting the adjustments.

## Adjusting the brightness and contrast (BRIGHTNESS/CONTRAST)

Brightness and contrast adjustments are made using a separate BRIGHTNESS/CONTRAST menu. These settings are stored in memory for all input signals.

- 1 **Move the control button in any direction.**  
The BRIGHTNESS/CONTRAST menu appears on the screen.

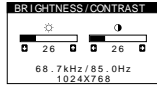

- 2 **Move the control button ↓/↑ to adjust the brightness (☀), and ←/→ to adjust the contrast (⦿).**  
The menu automatically disappears after about 3 seconds.

## Adjusting the horizontal size or centering of the picture (H-SIZE/CENTER)

These settings are stored in memory for the current input signal.

- 1 **Press the center of the control button.**  
The main MENU appears on the screen.
- 2 **Move the control button to highlight H-SIZE/CENTER, and press the center of the control button again.**  
The H-SIZE/CENTER menu appears on the screen.
- 3 **First move the control button ↓/↑ to select the desired adjustment item. Then move the control button ←/→ to make the adjustment.**

Select	To
H-SIZE	adjust the horizontal size
H-CENTER	adjust the horizontal centering

## Adjusting the vertical size or centering of the picture (V-SIZE/CENTER)

These settings are stored in memory for the current input signal.

- 1 **Press the center of the control button.**  
The main MENU appears on the screen.
- 2 **Move the control button to highlight V-SIZE/CENTER, and press the center of the control button again.**  
The V-SIZE/CENTER menu appears on the screen.
- 3 **First move the control button ↓/↑ to select the desired adjustment item. Then move the control button ←/→ to make the adjustment.**

Select	To
V-SIZE	adjust the vertical size
V-CENTER	adjust the vertical centering

## Adjusting the curvature of the picture's sides (PIN/PIN BALANCE)

These settings are stored in memory for the current input signal.

- 1 **Press the center of the control button.**  
The main MENU appears on the screen.
- 2 **Move the control button to highlight PIN/PIN BALANCE, and press the center of the control button again.**  
The PIN/PIN BALANCE menu appears on the screen.
- 3 **First move the control button ↓/↑ to select the desired adjustment item. Then move the control button ←/→ to make the adjustment.**

Select	To
PIN	expand or contract the picture sides
PIN BALANCE	shift the picture sides to the left or right

## Adjusting the angle of the picture's sides (KEY/KEY BALANCE)

These settings are stored in memory for the current input signal.

- 1 **Press the center of the control button.**  
The main MENU appears on the screen.
- 2 **Move the control button to highlight KEY/KEY BALANCE, and press the center of the control button again.**  
The KEY/KEY BALANCE menu appears on the screen.
- 3 **First move the control button ↓/↑ to select the desired adjustment item. Then move the control button ←/→ to make the adjustment.**

Select	To
KEY	adjust the picture width at the top of the screen
KEY BALANCE	shift the picture to the left or right at the top of the screen

## Adjusting the picture's rotation (ROTATION)

This setting is stored in memory for all input signals.

- 1 **Press the center of the control button.**  
The main MENU appears on the screen.
- 2 **Move the control button to highlight ROTATION, and press the center of the control button again.**  
The ROTATION menu appears on the screen.
- 3 **Move the control button ←/→ to rotate the picture.**

## Enlarging or reducing the picture (ZOOM)

This setting is stored in memory for the current input signal.

- 1 **Press the center of the control button.**  
The main MENU appears on the screen.
- 2 **Move the control button to highlight ZOOM and press the center of the control button again.**  
The ZOOM menu appears on the screen.
- 3 **Move the control button ←/→ to enlarge or reduce the picture.**

### Note

Adjustment stops when either the horizontal or vertical size reaches its maximum or minimum value.

## Adjusting the color of the picture (COLOR)

The COLOR settings allow you to adjust the picture's color temperature by changing the color level of the white color field. Colors appear reddish if the temperature is low, and bluish if the temperature is high. This adjustment is useful for matching the monitor's colors to a printed picture's colors. This setting is stored in memory for all input signals.

- 1 **Press the center of the control button.**  
The main MENU appears on the screen.
- 2 **Move the control button to highlight COLOR and press the center of the control button again.**  
The COLOR menu appears on the screen.
- 3 **Move the control button ←/→ to select a color temperature.**  
The preset color temperatures are 5000K, 6500K, and 9300K. Since the default setting is 9300K, the whites will change from a bluish hue to a reddish hue as the temperature is lowered to 6500K and 5000K.
- 4 **If necessary, fine tune the color temperature.**  
First move the control button ←/→ to select USER. Then move the control button ↓/↑ button to select R (red), G (green), or B (blue) and move the control button ←/→ to make the adjustment.

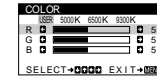

If you fine tune the color temperature, the new color settings are stored in memory and recalled whenever you select USER.

## Additional settings (DEGAUSS/CANCEL MOIRE)

You can manually degauss (demagnetize) the screen, and cancel the moire.

- 1 Press the center of the control button.**  
The main MENU appears on the screen.
- 2 Move the control button ↓/↑ to highlight ⏏ DEGAUSS/CANCEL MOIRE and press the center of the control button again.**  
The DEGAUSS/CANCEL MOIRE menu appears on the screen.
- 3 Move the control button ↓/↑ to select the desired adjustment item.**  
Adjust the selected item according to the following instructions.

### Degaussing the screen

The monitor is automatically demagnetized when the power is turned on.

**To manually degauss the monitor, first move the control button ↓/↑ to select ⏏ (DEGAUSS). Then move the control button →.**

The screen is degaussed for about 5 seconds. If a second degauss cycle is needed, allow a minimum interval of 20 minutes for the best result.

### Cancelling the moire\*

If elliptical or wavy patterns appear on the screen, adjust the moire cancellation level.

**To adjust the amount of moire cancellation, first move the control button ↓/↑ to select ⏏ (CANCEL MOIRE). Then move the control button ←/→ until the moire effect is at a minimum.**

\* Moire is a type of natural interference which produces soft, wavy lines on your screen. It may appear due to interference between the pattern of the picture on the screen and the phosphor pitch pattern of the monitor.

Example of moire



## Resetting the adjustments (RESET)

This monitor has the following two reset methods. Use the RESET menu to reset the adjustments.

- 1 Press the center of the control button.**  
The main MENU appears on the screen.
- 2 Move the control button ↓/↑ to highlight ⏏ RESET and press the center of the control button again.**  
The RESET menu appears on the screen.  
Reset the settings according to the following instructions.

### Resetting all of the adjustment data for the current input signal (MODE)

#### Move the control button ←.

The MODE item is selected. All of the adjustment data for the current input signal is reset.

Note that the following items are not reset by this method.

- on-screen menu language (page 8)
- picture's rotation (page 11)

### Resetting all of the adjustment data to factory preset levels (ALL)

#### Move the control button →.

The ALL item is selected. All of the adjustment data for the current input signal is reset. All of the adjustment data (except for the USER settings in the COLOR menu) is reset to the factory preset levels.

#### Note

The monitor's buttons will not operate for about 5 seconds when ALL is selected.

## Technical Features

### Preset and user modes

When the monitor receives an input signal, it automatically matches the signal to one of the factory preset modes stored in the monitor's memory to provide a high quality picture at the center of the screen. (See Appendix for a list of the factory preset modes.) For input signals that do not match one of the factory preset modes, the digital Multiscan technology of this monitor ensures that a clear picture appears on the screen for any timing in the monitor's frequency range (horizontal: 30 – 70 kHz, vertical: 48 – 120 Hz). If the picture is adjusted, the adjustment data is stored as a user mode and automatically recalled whenever the same input signal is received.

#### Note for Windows users

For Windows users, check your video board manual or the utility program which comes with your graphic board and select the highest available refresh rate to maximize monitor performance.

### Power saving function

This monitor meets the power-saving guidelines set by VESA, ENERGY STAR, and NUTEK. If the monitor is connected to a computer or video graphics board that is DPMS (Display Power Management Signaling) compliant, the monitor will automatically reduce power consumption in three stages as shown below.

Power mode	Power consumption*	⏻ (power) indicator
normal operation	≤ 115 W (HMD-A200) ≤ 95 W (HMD-A100)	green
1 standby	≤ 15 W	green and orange alternate
2 suspend	≤ 15 W	green and orange alternate
3 active off**	≤ 5 W	orange
power off	0 W	off

\* Figures reflect power consumption when no USB compatible peripherals are connected to the monitor.

\*\*When your computer enters the "active off" mode, the input signal is cut and NO INPUT SIGNAL appears on the screen. After 20 seconds, the monitor enters the power saving mode.

## Troubleshooting

Before contacting technical support, refer to this section.

### If thin lines appear on your screen (damper wires)

The lines you are experiencing on your screen are normal for the Trinitron monitor and are not a malfunction. These are shadows from the damper wires used to stabilize the aperture grille and are most noticeable when the screen's background is light (usually white). The aperture grille is the essential element that makes a Trinitron picture tube unique by allowing more light to reach the screen, resulting in a brighter, more detailed picture.

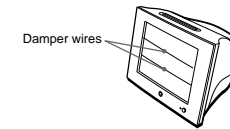

### On-screen messages

GB

If there is something wrong with the input signal, one of the following messages appears on the screen. To solve the problem, see "Trouble symptoms and remedies" on page 14.



#### The input signal condition

##### OUT OF SCAN RANGE





indicates that the input signal is not supported by the monitor's specifications.

##### NO INPUT SIGNAL

indicates that no signal is being input to the monitor.

## Trouble symptoms and remedies





If the problem is caused by the connected computer or other equipment, please refer to the connected equipment's instruction manual. Use the self-diagnosis function (page 16) if the following recommendations do not resolve the problem.

Symptom	Check these items
<b>No picture</b>	
If the  (power) indicator is not lit	<ul style="list-style-type: none"> <li>Check that the power cord is properly connected.</li> <li>Check that the  (power) switch is in the "on" position.</li> </ul>
If the NO INPUT SIGNAL message appears on the screen, or if the  (power) indicator is either orange or alternating between green and orange	<ul style="list-style-type: none"> <li>Check that the video signal cable is properly connected and all plugs are firmly seated in their sockets (page 6).</li> <li>Check that the HD15 video input connector's pins are not bent or pushed in.</li> </ul> <p>■ <b>Problems caused by the connected computer or other equipment</b></p> <ul style="list-style-type: none"> <li>The computer is in power saving mode. Try pressing any key on the computer keyboard.</li> <li>Check that the computer's power is "on."</li> <li>Check that the graphic board is completely seated in the proper bus slot.</li> </ul>
If the OUT OF SCAN RANGE message appears on the screen	<p>■ <b>Problems caused by the connected computer or other equipment</b></p> <ul style="list-style-type: none"> <li>Check that the video frequency range is within that specified for the monitor. If you replaced an old monitor with this monitor, reconnect the old monitor and adjust the frequency range to the following. Horizontal: 30 – 70 kHz Vertical: 48 – 120 Hz</li> </ul>
If no message is displayed and the  (power) indicator is green or flashing orange	<ul style="list-style-type: none"> <li>Use the Self-diagnosis function (page 16).</li> </ul>
If using Windows 95/98	<ul style="list-style-type: none"> <li>If you replaced an old monitor with this monitor, reconnect the old monitor and do the following. Install the Windows Monitor Information Disk (page 7) and select this monitor ("HMD-A100" or "HMD-A200") from among the Sony monitors in the Windows 95/98 monitor selection screen.</li> </ul>
If using a Macintosh system	<ul style="list-style-type: none"> <li>Check that the Macintosh adapter (not supplied) and the video signal cable are properly connected (page 6).</li> </ul>
<b>Picture flickers, bounces, oscillates, or is scrambled</b>	<ul style="list-style-type: none"> <li>Isolate and eliminate any potential sources of electric or magnetic fields such as other monitors, laser printers, electric fans, fluorescent lighting, or televisions.</li> <li>Move the monitor away from power lines or place a magnetic shield near the monitor.</li> <li>Try plugging the monitor into a different AC outlet, preferably on a different circuit.</li> <li>Try turning the monitor 90° to the left or right.</li> </ul> <p>■ <b>Problems caused by the connected computer or other equipment</b></p> <ul style="list-style-type: none"> <li>Check your graphics board manual for the proper monitor setting.</li> <li>Confirm that the graphics mode (VESA, Macintosh 16" Color, etc.) and the frequency of the input signal are supported by this monitor (Appendix). Even if the frequency is within the proper range, some video boards may have a sync pulse that is too narrow for the monitor to sync correctly.</li> <li>Adjust the computer's refresh rate (vertical frequency) to obtain the best possible picture.</li> </ul>
<b>Picture is fuzzy</b>	<ul style="list-style-type: none"> <li>Adjust the brightness and contrast (page 10).</li> <li>Degauss the monitor* (page 12).</li> <li>Decrease the moire cancellation effect (page 12).</li> </ul>
<b>Picture is ghosting</b>	<ul style="list-style-type: none"> <li>Eliminate the use of video cable extensions and/or video switch boxes.</li> <li>Check that all plugs are firmly seated in their sockets.</li> </ul>

Symptom	Check these items
<b>Picture is not centered or sized properly</b>	<ul style="list-style-type: none"> <li>Adjust the size or centering (page 10). Note that some video modes do not fill the screen to the edges.</li> </ul>
<b>Edges of the image are curved</b>	<ul style="list-style-type: none"> <li>Adjust the shape of the picture (page 10).</li> </ul>
<b>Wavy or elliptical pattern (moire) is visible</b>	<ul style="list-style-type: none"> <li>Cancel the moire (page 12).</li> </ul> <p>■ <b>Problems caused by the connected computer or other equipment</b></p> <ul style="list-style-type: none"> <li>Change your desktop pattern.</li> </ul>
<b>Color is not uniform</b>	<ul style="list-style-type: none"> <li>Degauss the monitor* (page 12). If you place equipment that generates a magnetic field, such as a speaker, near the monitor, or if you change the direction the monitor faces, color may lose uniformity.</li> </ul>
<b>White does not look white</b>	<ul style="list-style-type: none"> <li>Adjust the color temperature (page 11).</li> </ul>
<b>USB peripherals do not function</b>	<ul style="list-style-type: none"> <li>Check that the appropriate USB connectors are securely connected (page 7).</li> <li>Check that the  (power) switch is in the "on" position.</li> </ul> <p>■ <b>Problems caused by the connected computer or other equipment</b></p> <ul style="list-style-type: none"> <li>Check that the power of any self-powered USB compliant peripheral devices is "on."</li> <li>Install the latest version of the device driver on your computer. Contact your device's manufacturer for information about the appropriate device driver.</li> <li>If your USB compliant keyboard or mouse does not function, connect them directly to your computer, reboot your computer, and make any necessary adjustments to the USB settings. Then reconnect the keyboard or mouse to the monitor.</li> <li>For customers using Windows 95             <ol style="list-style-type: none"> <li>Right-click on My Computer and select Properties.</li> <li>Click on the Device Manager tab. Scroll down and select Universal Serial Bus Controller.                 <ul style="list-style-type: none"> <li>→ If Universal Serial Bus Controller does not appear, you need to load a USB supplement disk. Contact your computer's manufacturer for more information about obtaining a USB supplement disk.</li> </ul> </li> <li>Select Generic USB Device from the USB controller list and click on Properties.</li> <li>If there is a check in the box next to "Disable in this hardware profile," remove the check.</li> <li>Click on Refresh.</li> </ol> </li> </ul>
<b>A hum is heard right after the power is turned on</b>	<ul style="list-style-type: none"> <li>This is the sound of the auto-degauss cycle. When the power is turned on, the monitor is automatically degaussed for 5 seconds.</li> </ul>

\* If a second degauss cycle is needed, allow a minimum interval of 20 minutes for the best result. A humming noise may be heard, but this is not a malfunction.

### Displaying this monitor's name, serial number, and date of manufacture (INFORMATION)

- Press the center of the control button.**  
The main MENU appears on the screen.
- Move the control button to highlight  LANGUAGE/ INFORMATION and press the center of the control button.**  
The LANGUAGE/INFORMATION menu appears on the screen.
- Move the control button /  to select  (INFORMATION) and press the center of the control button.**

This monitor's information box appears on the screen.

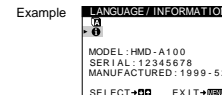

If the problem persists, call your authorized Sony dealer and give the following information.

- Model name: HMD-A100, HMD-A200
- Serial number
- Name and specifications of your computer and graphics board.

GB

## Self-diagnosis function

This monitor is equipped with a self-diagnosis function. If there is a problem with your monitor or computer, the screen will go blank and the ⏻ (power) indicator will either light up green or flash orange. If the ⏻ (power) indicator is lit in orange, the computer is in power saving mode. Try pressing any key on the keyboard.

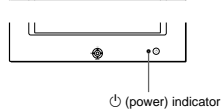

### If the ⏻ (power) indicator is green

- 1 Disconnect the video input cable, or turn off the connected computer.
- 2 Press the ⏻ (power) button to turn the monitor off and on.
- 3 Move the control button → for 2 seconds before the monitor enters power saving mode.

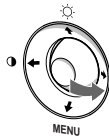

If all three color bars appear (red, green, blue), the monitor is working properly. Reconnect the video input cables and check the condition of your computer.

If the color bars do not appear, there is a potential monitor failure. Inform your authorized Sony dealer of the monitor's condition.

### If the ⏻ (power) indicator is flashing orange

Press the ⏻ (power) button to turn the monitor off and on.

If the ⏻ (power) indicator lights up green, the monitor is working properly.

If the ⏻ (power) indicator is still flashing, there is a potential monitor failure. Count the number of seconds between orange flashes of the ⏻ (power) indicator and inform your authorized Sony dealer of the monitor's condition. Be sure to note the model name and serial number of your monitor. Also note the make and model of your computer and video board.

## SECTION 2 DISASSEMBLY

### 2-1. BUCKET REMOVAL

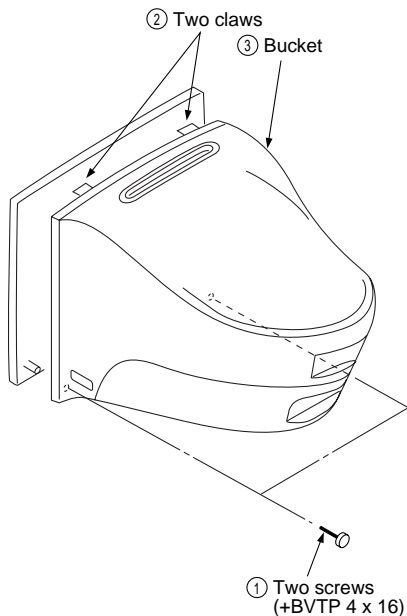

### 2-3. H BOARD REMOVAL

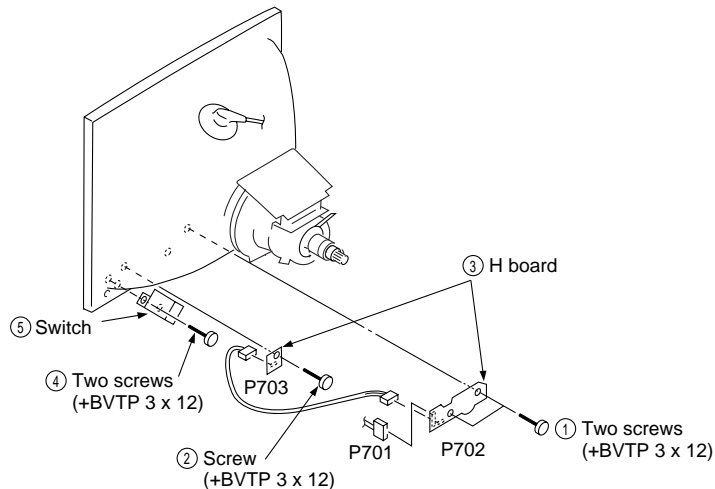

### 2-2. A, D, U1 AND U2 BOARDS REMOVAL

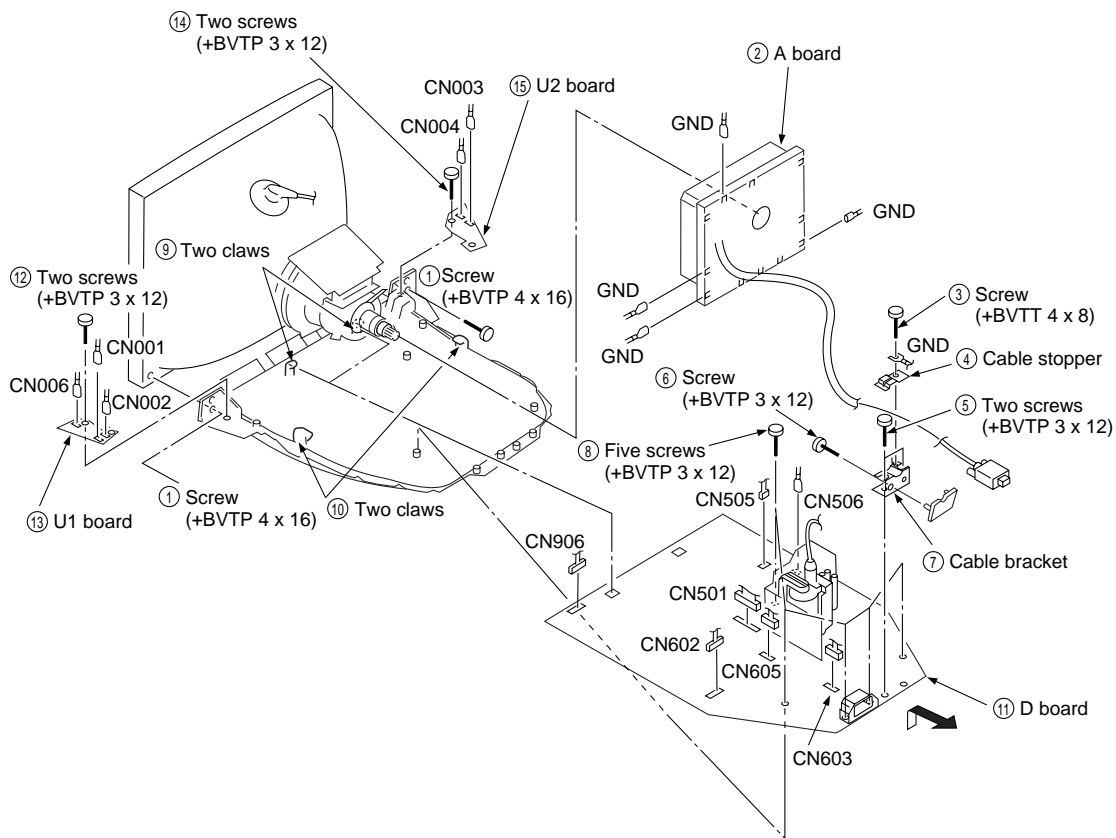

## 2-4. PICTURE TUBE REMOVAL

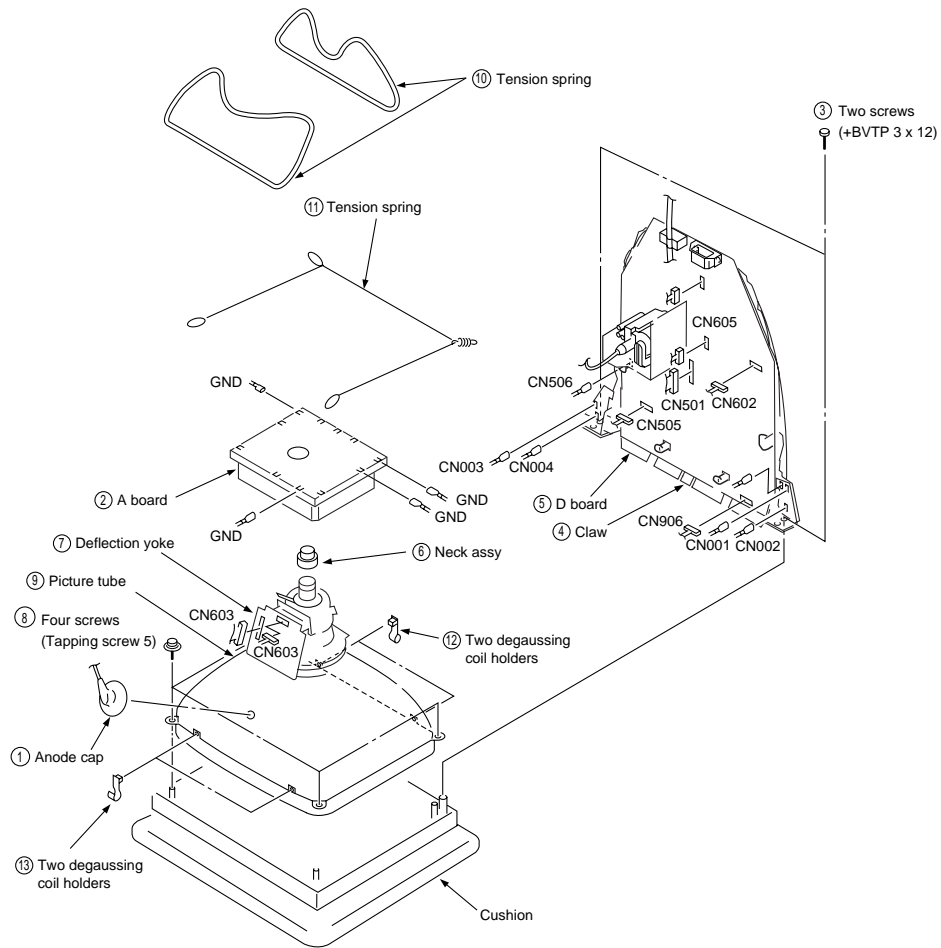

### • REMOVAL OF ANODE-CAP

NOTE: Short circuit the anode of the picture tube and the anode cap to the metal chassis, CRT shield or carbon painted on the CRT, after removing the anode.

### • REMOVING PROCEDURES

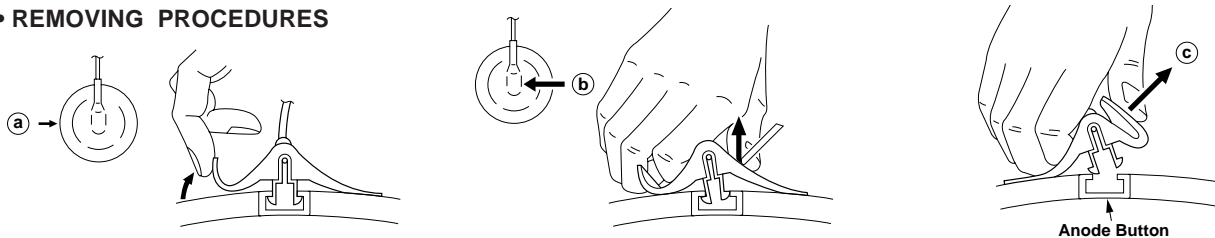

- ① Turn up one side of the rubber cap in the direction indicated by the arrow (a).
- ② Using a thumb pull up the rubber cap firmly in the direction indicated by the arrow (b).
- ③ When one side of the rubber cap is separated from the anode button, the anode-cap can be removed by turning up the rubber cap and pulling up it in the direction of the arrow (c).

### • HOW TO HANDLE AN ANODE-CAP

- ① Don't scratch the surface of anode-caps with sharp shaped material!
- ② Don't press the rubber hardy not to damage inside of anode-caps! A material fitting called as shatter-hook terminal is built in the rubber.
- ③ Don't turn the foot of rubber over hardy! The shatter-hook terminal will stick out or damage the rubber.

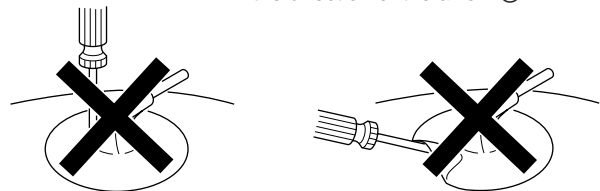

2-5. HARNESS LOCATION

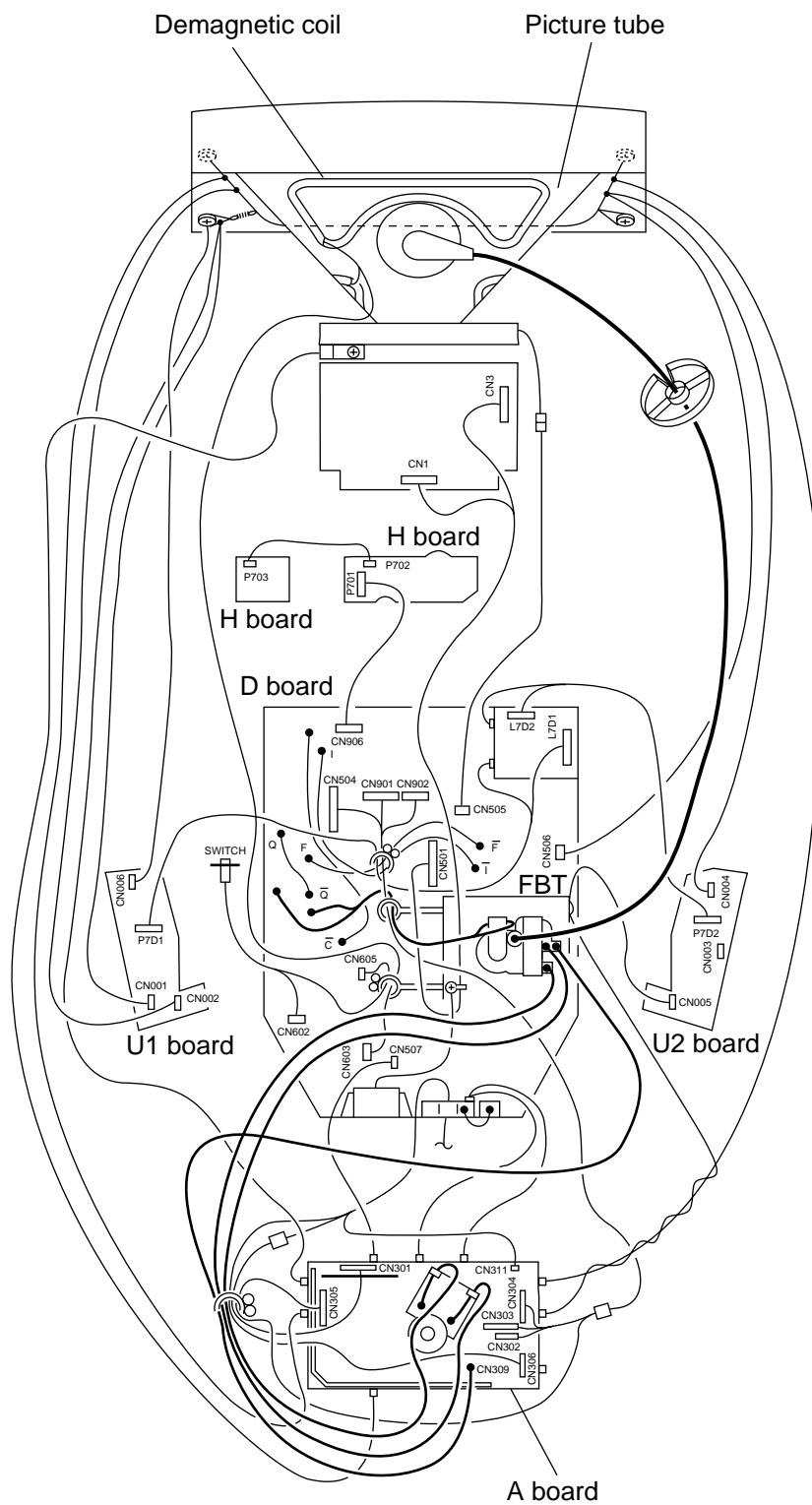



## SAFETY RELATED ADJUSTMENT

When replacing or repairing the shown below table, the following operational checks must be performed as a safety precaution against X-rays emissions from the unit.

	Part Replaced (☒)
HV ADJ	RV501

	Part Replaced (☑)
HV Regulator Circuit Check	D board IC502, IC503, Q511, D510, C535, R515, R554, R559, R560, R596, RV501, T501 (FBT)
HV Hold-down Circuit Check	D board IC501, R598, R599, T501 (FBT)
Beam Current Protector Circuit Check	D board T501 (FBT)

\* Confirm one minute later turning on the power.

- **HV Protector Circuit Check**

Confirm that the voltage between cathode of D521 on D board and GND is more than 28.5 V DC and Using external DC Power Supply, apply the voltage shown below between cathode of D521 and GND, and confirm that the HV HOLD DOWN circuite works. (TV Raster disappears)

Standard voltage : Less than 34 V DC

**Check Condition**

- Input voltage : 100 – 120 V AC
- Input signal : White Cross hatch at Max fH
- Beam control : CONT : 255, BRT : 80

- **Beam Current Protector Check**

Connect a variable resistor (250 kΩ or more) and an ammeter in series between FBT pin ① on D board and GND. Decrease gradually the resistance of the variable resistor from maximum to minimum, and confirm that the Beam Current Protector Circuite works (TV Raster disappears). The current must be within the range shown below.

• Standard current : Less than 1.50 mA

**Check Condition**

- Input voltage : 100 – 120 V AC
- Input signal : White Cross hatch at Max fH
- Beam control : CONT : 255, BRT : 80

- **B+ Voltage Check**

Standard voltage :  $152 \pm 5.0$  V DC

**Check Condition**

- Input voltage : 100 – 120 V AC  
Note : Use NF power supply or make sure that distortion factor is 3% or less.
- Input signal : White Cross hatch at 64.0 kHz
- Beam control : CONT : 255, BRT : 80

## SECTION 4 ADJUSTMENTS

Connect the communication cable of the computer to the connector located on the monitor. Run the service software and then follow the instruction.

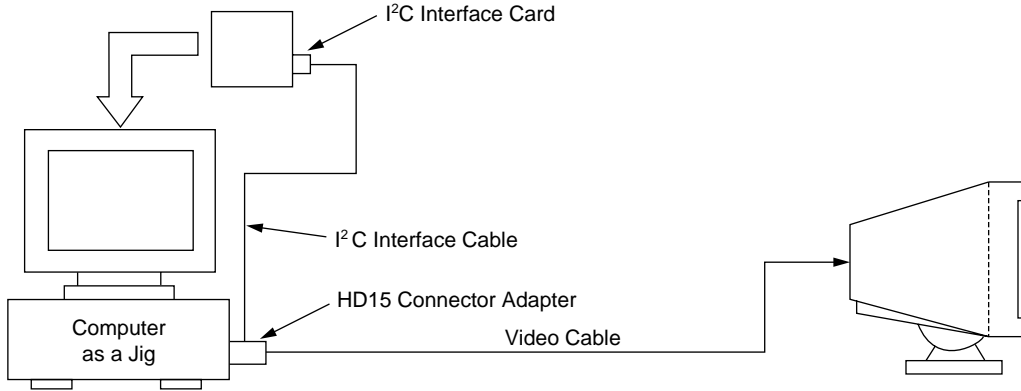

### • Landing Fine Adjustment

1. Put the set inside the Helmholtz coil.
  2. Set TLH plate to zero position.
  3. Input the single green signal.
  4. Demagnetize the CRT surface with the hand degausser , and perform auto degaussing.
  5. Attach the wobbling coil to the designated part of the CRT neck.
  6. Attach the sensor of the landing adjustment unit on the CRT surface.  
Purity magnet position
  7. Adjust the DY position and purity, and the DY tilt.
  8. Fasten DY with screw.
- Note: Torque 20 ±1kgcm
9. Adjust top and bottom pins by pitching DY up and down with two wedges.  
Also leave the yaw of DY to physical center position with Another two wedes.

L/D control specification

± 5	± 7	± 5	(μm)
± 5	± 7	± 5	
± 5	± 7	± 5	

10. If the corner landing is out of specification, put a disk magnet for the landing correction.
11. Perform auto degauss in case disk magnets are used.
12. Remove the sensor and wobbling coil.
13. Fix purity magnet on DY with UL black tape.

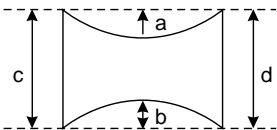

“a” and “b” must be equal, and  
“c” and “d” must be equal.

<How to drive in wedges>

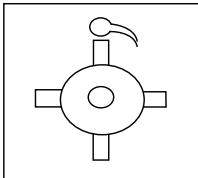

• **Convergence Rough Adjustment**

1. Enter the crosshatch signal.
2. Recheck focus and readjust when focus was worse.
3. Adjust roughly H. STAT and V. STAT convergence by 4 pole magnet.
4. Adjust roughly HMC and VMC by 6 pole magnet.

• **Convergence Adjustment**

1. Open H and V Stat by 4 pole magnet.
2. Adjust 6 pole magnet perform HMC and VMC.
3. Adjust 4 pole magnet close both Stat of R.G.B just overlap each other Horizontal and Vertical.
4. Adjust TLH for side MC by TLH magnet when R or B is in the opposite direction.
5. Adjust XCV to correct Vertical cross MC.
6. Adjust XBV to correct Vertical bow MC.
7. Adjust TLV to correct Vertical tilt MC.
8. Adjust YCH to correct top and bottom Horizontal cross MC.
9. Adjust YBH to correct top and bottom Horizontal bow MC.
10. Using permalloys to correct MC of the corners.
11. Check convergence for whole screen. If necessary, perform step from 3-9 and correct with permalloys.
12. Paint lock 4 pole magnet, 6 poles magnets, XBV reactor and TLH corrector handle.

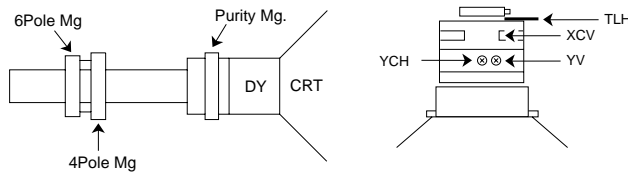

• **Convergence Specification**

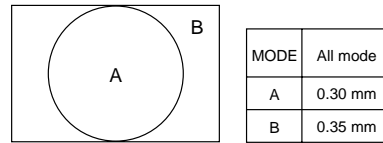

• **White Balance Adjustment Specification**

- |                  |                  |
|------------------|------------------|
| (1) 9300K        | (2) 6500K        |
| x = 0.283 ± 0.01 | x = 0.313 ± 0.01 |
| y = 0.298 ± 0.01 | y = 0.329 ± 0.01 |
| (2) 5000K        |                  |
| x = 0.346 ± 0.01 |                  |
| y = 0.359 ± 0.01 |                  |

• **Vertical and Horizontal Position and Size Specification**

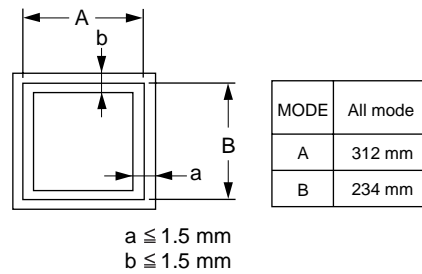

• **Focus adjustment**

Adjust the focus volume 1 and 2 for the optimum focus.

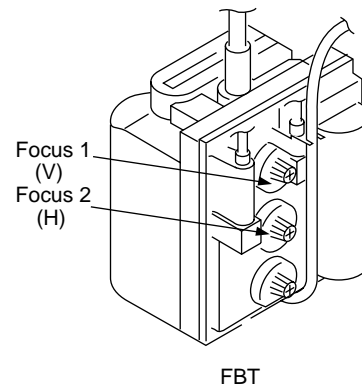
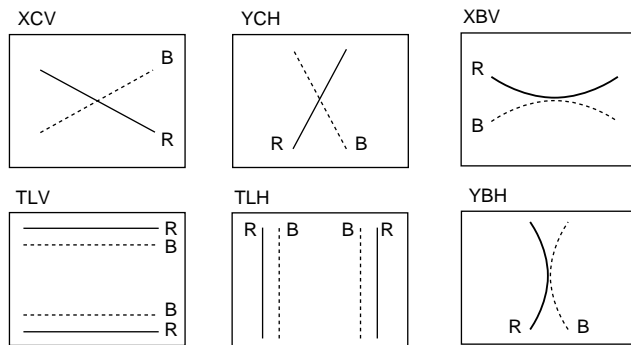



# SECTION 5 DIAGRAMS

## 5-1. BLOCK DIAGRAMS

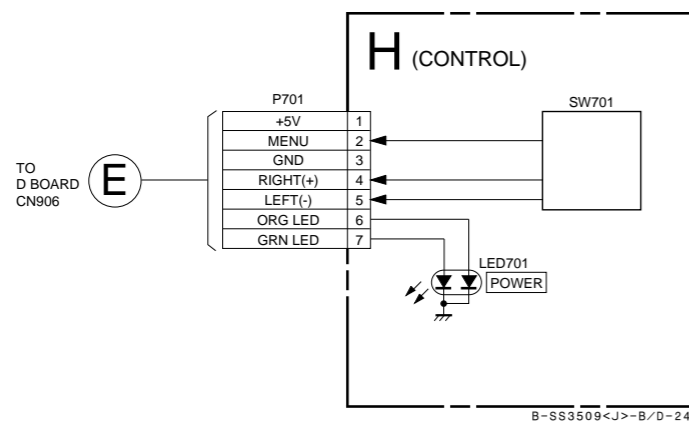
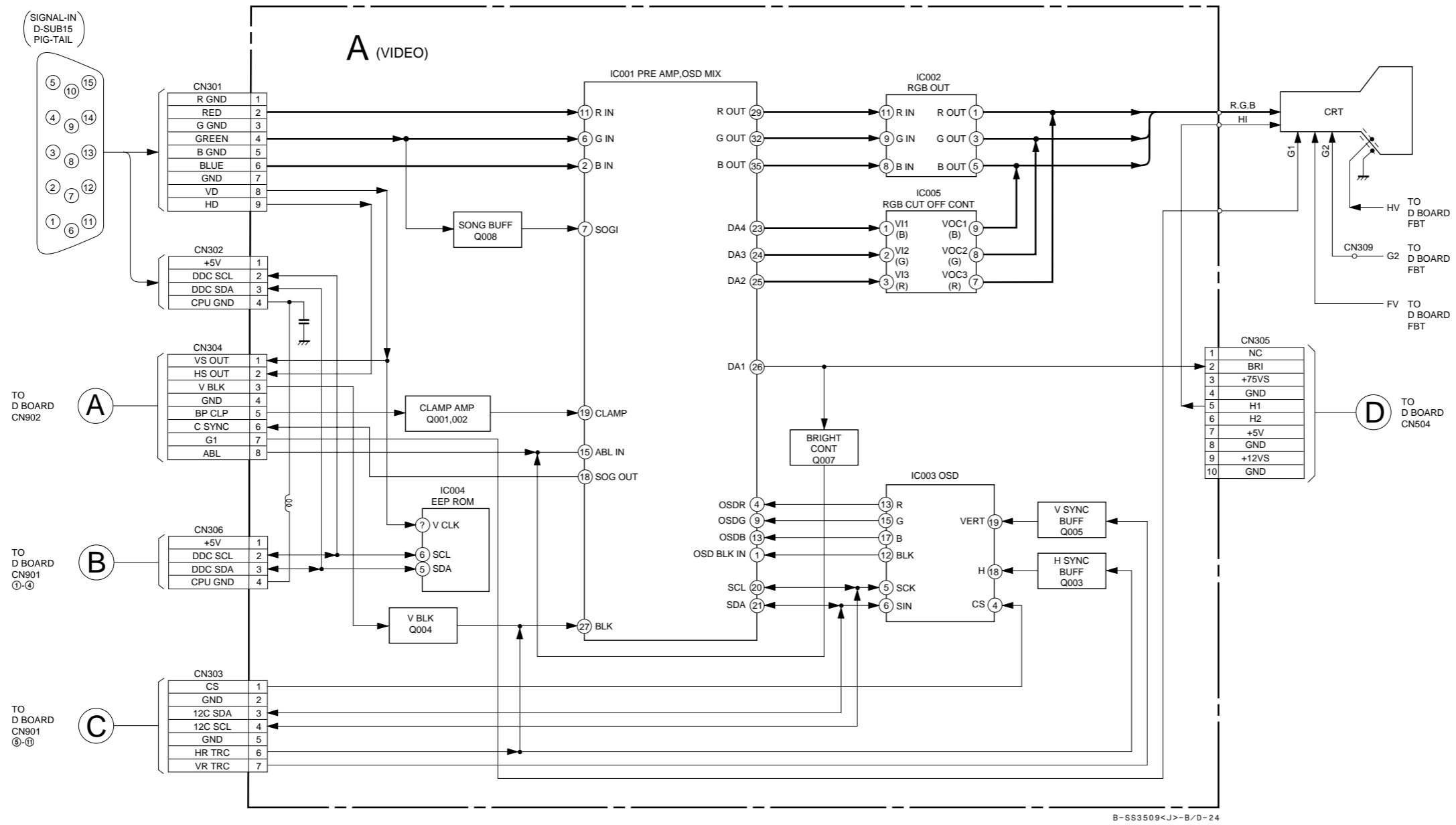

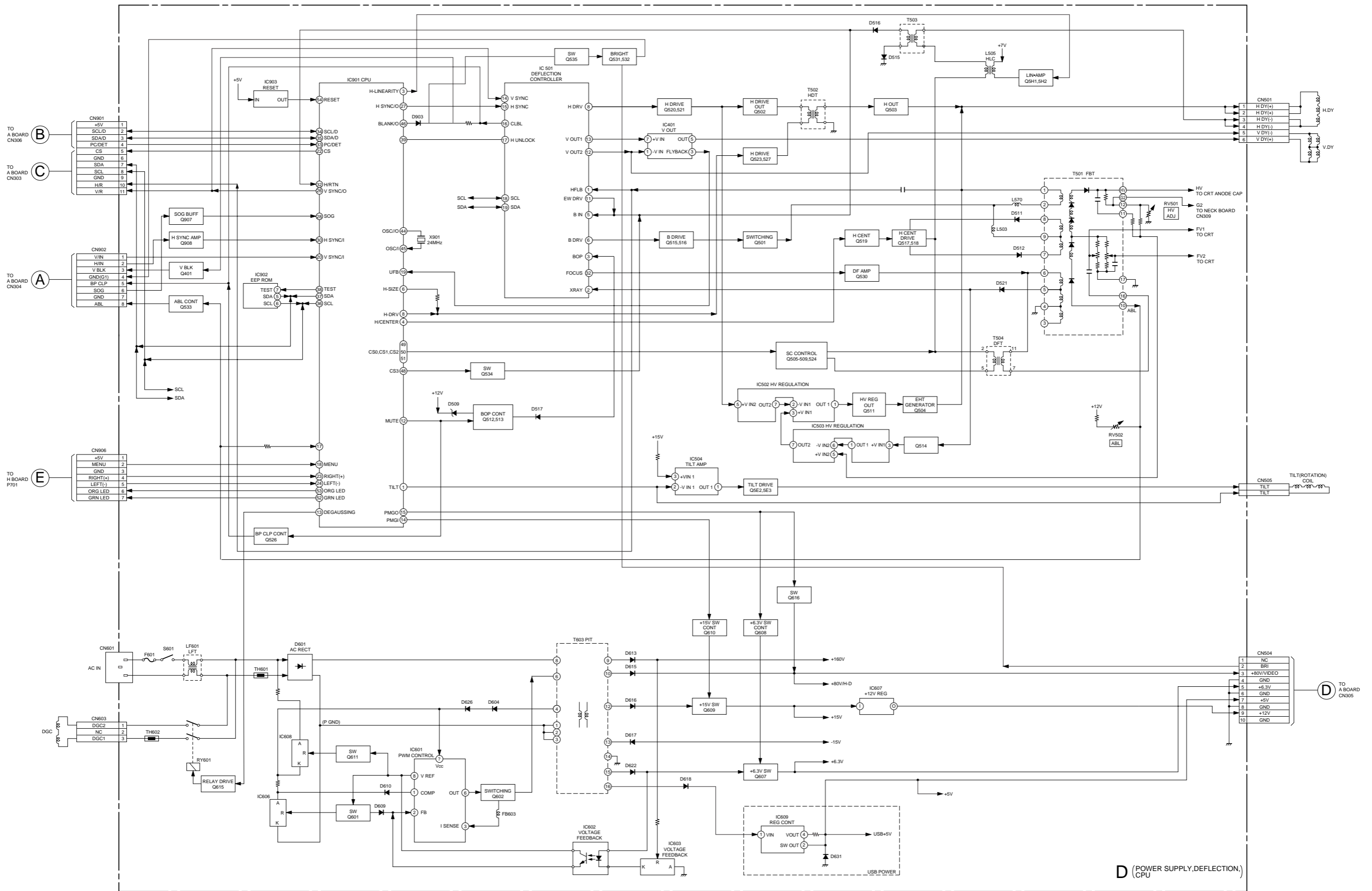

**D (POWER SUPPLY, DEFLECTION), CPU**

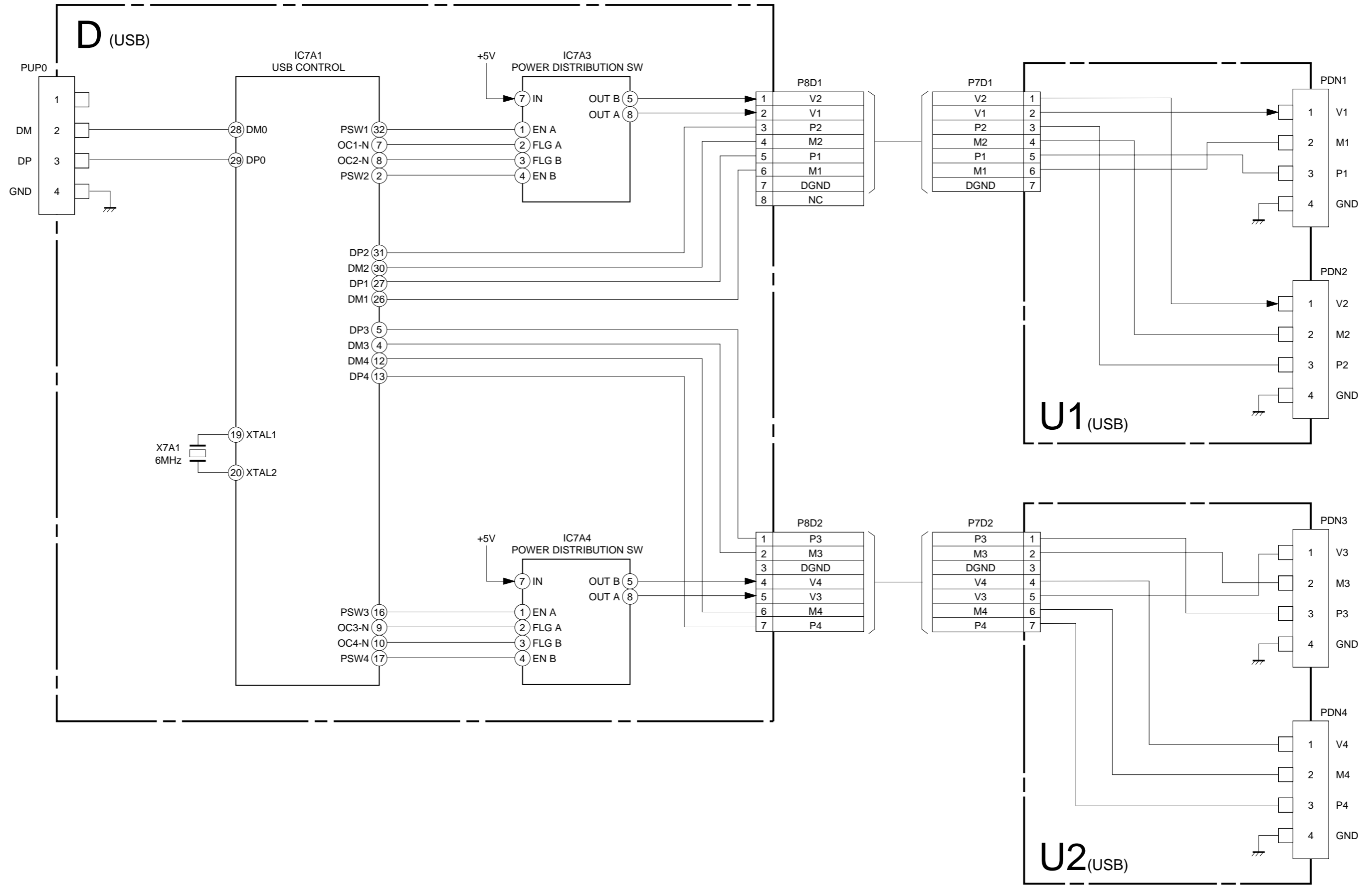

B-SS3509<J>-B/D-24

## 5-2. CIRCUIT BOARDS LOCATION

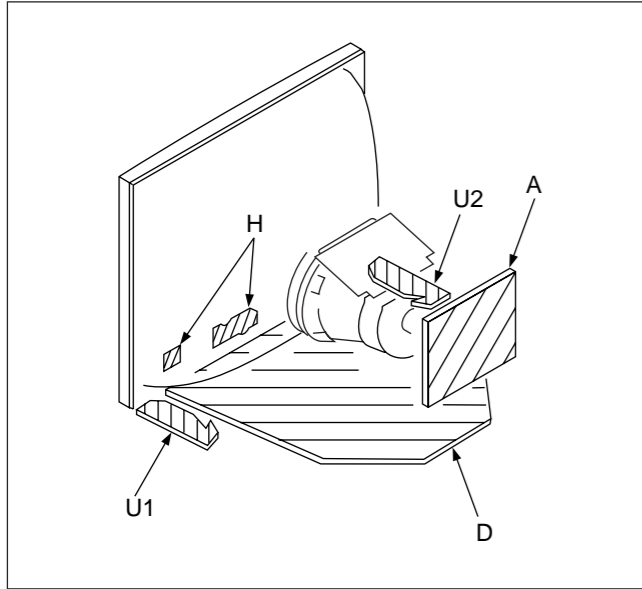

## 5-3. SCHEMATIC DIAGRAMS AND PRINTED WIRING BOARDS

### Note:

- All capacitors are in  $\mu\text{F}$  unless otherwise noted. (pF:  $\mu\mu\text{F}$ ) Capacitors without voltage indication are all 50 V.
- Indication of resistance, which does not have one for rating electrical power, is as follows.

Pitch: 5 mm  
Rating electrical power 1/4 W (CHIP : 1/10 W)

- All resistors are in ohms.
- : nonflammable resistor.
- : fusible resistor.
- $\triangle$  : internal component.
- : panel designation, and adjustment for repair.
- All variable and adjustable resistors have characteristic curve B, unless otherwise noted.
- $\perp$  : earth-ground.
- : earth-chassis.
- All voltages are in V.
- Readings are taken with a 10 M $\Omega$  digital multimeter.
- Readings are taken with a color-bar signal input.
- Voltage variations may be noted due to normal production tolerances.
- \* : Can not be measured.
- Circled numbers are waveform references.
- : B + bus.
- : B - bus.
- The components identified by in this basic schematic diagram have been carefully factory-selected for each set in order to satisfy regulations regarding X-ray radiation. Should replacement be required, replace only with the value originally used.
- When replacing components identified by , make the necessary adjustments indicated. (See page 3-1)
- When replacing the part in below table, be sure to perform the related adjustment.

	Part Replaced ()
HV ADJ	RV501

	Part Replaced ()
HV Regulator Circuit Check	D board IC502, IC503, Q511, D510, C535, R515, R554, R559, R560, R596, RV501, T501 (FBT)
HV Hold-down Circuit Check	D board IC501, R598, R599, T501 (FBT)
Beam Current Protector Circuit Check	D board T501 (FBT)

- Divided circuit diagram  
One sheet of D board circuit diagram is divided into three sheets, each having the code D- $\text{\textcircled{a}}$  to D- $\text{\textcircled{c}}$ . For example, the destination  $\text{\textcircled{ab1}}$  on the D- $\text{\textcircled{a}}$  sheet is connected to  $\text{\textcircled{ab1}}$  on the D- $\text{\textcircled{b}}$  sheet.

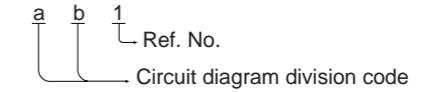

**Note: The components identified by shading and mark  $\triangle$  are critical for safety. Replace only with part number specified.**

**Note: Les composants identifiés par un tramé et une marque  $\triangle$  sont critiques pour la sécurité. Ne les remplacer que par une pièce portant le numéro spécifié.**



(1) Schematic Diagram of U1 and U2 Boards

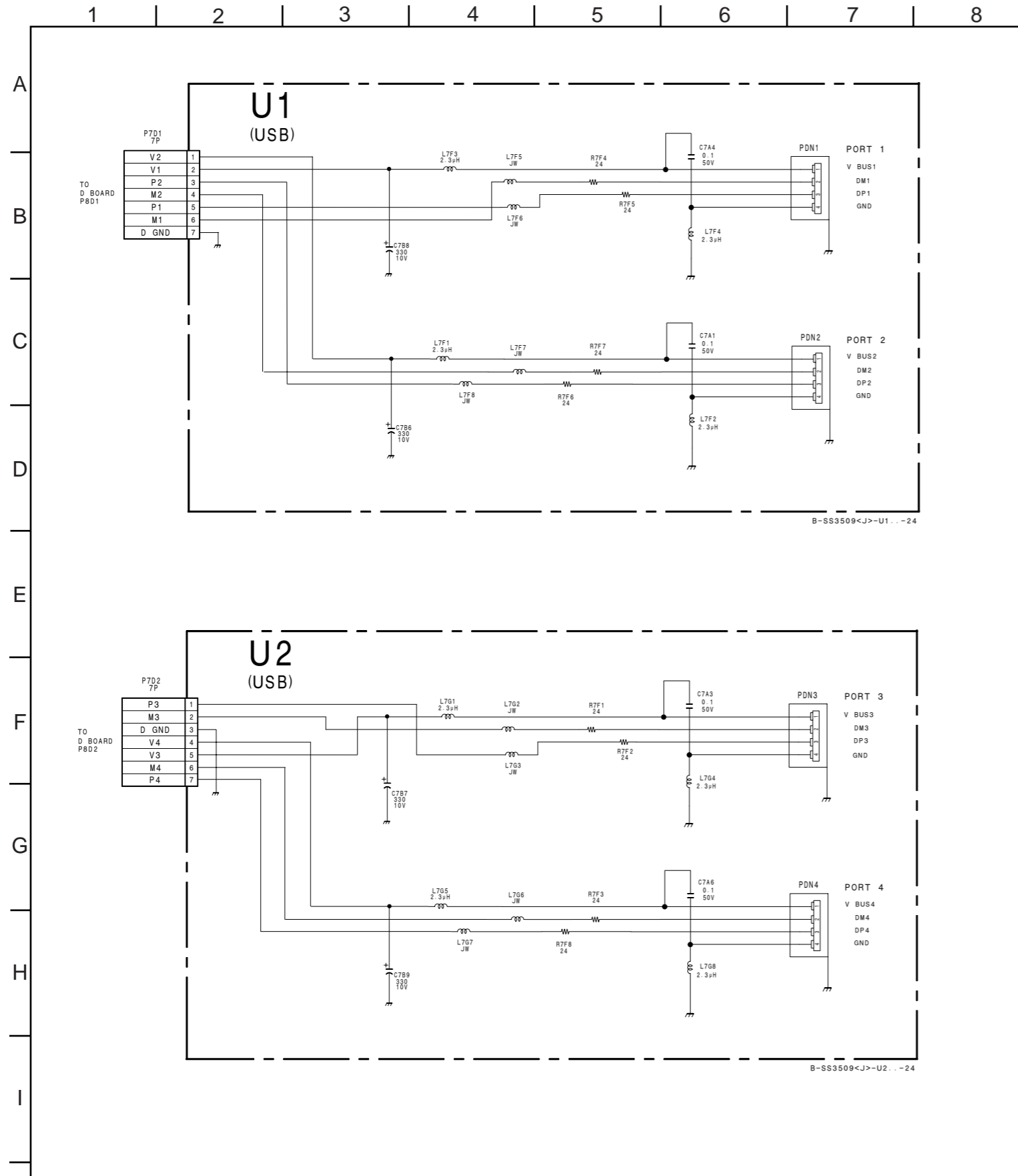

(2) Schematic Diagram of A Board

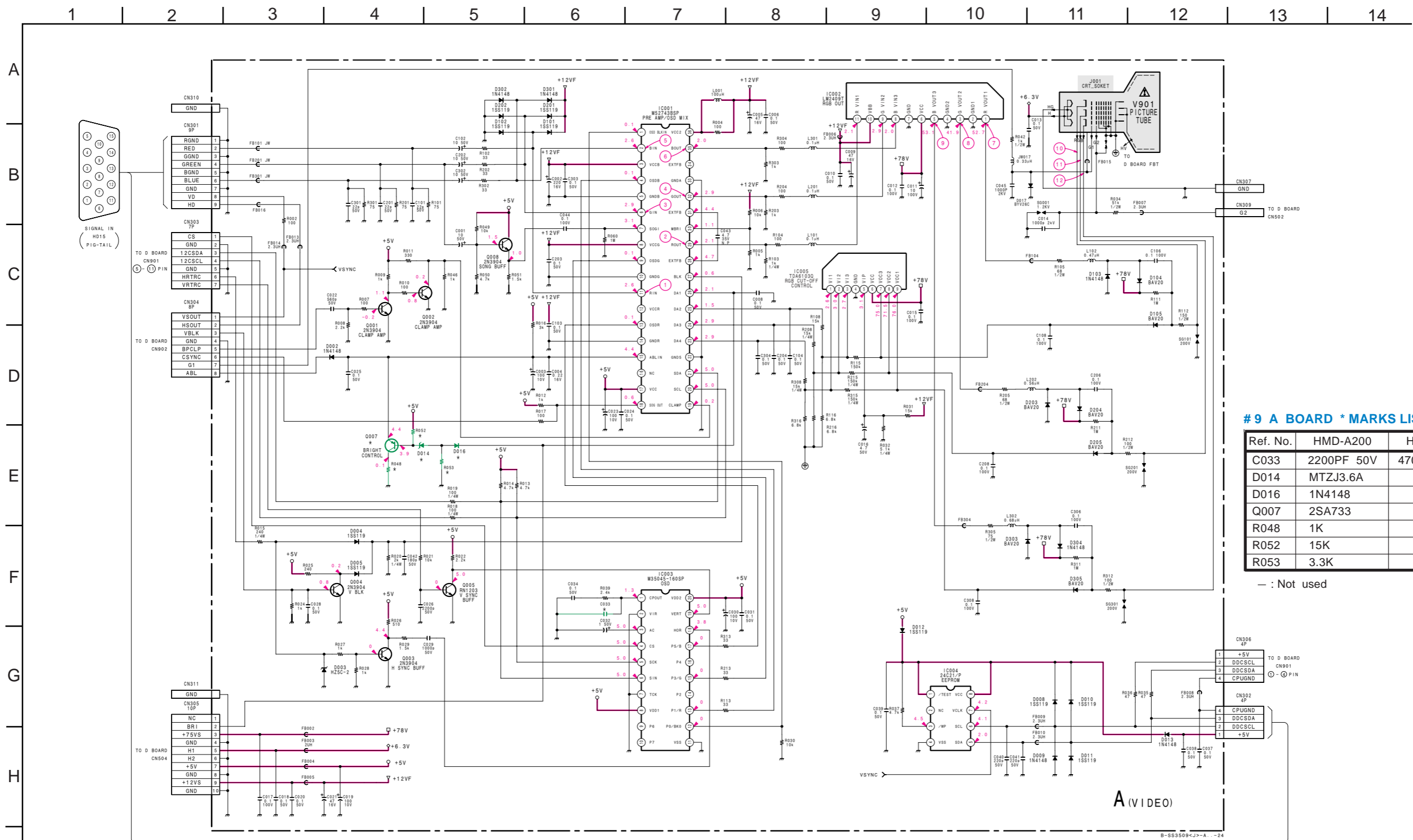

**# 9 A BOARD \* MARKS LIST**

Ref. No.	HMD-A200	HMD-A220
C033	2200PF 50V	4700PF 50V
D014	MTZJ3.6A	—
D016	1N4148	—
Q007	2SA733	—
R048	1K	—
R052	15K	—
R053	3.3K	—

— : Not used

• A BOARD WAVEFORMS

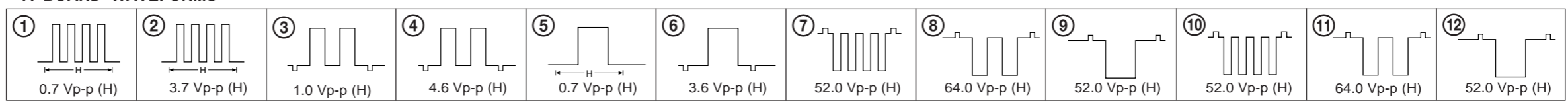

— A BOARD (Conductor Side) —

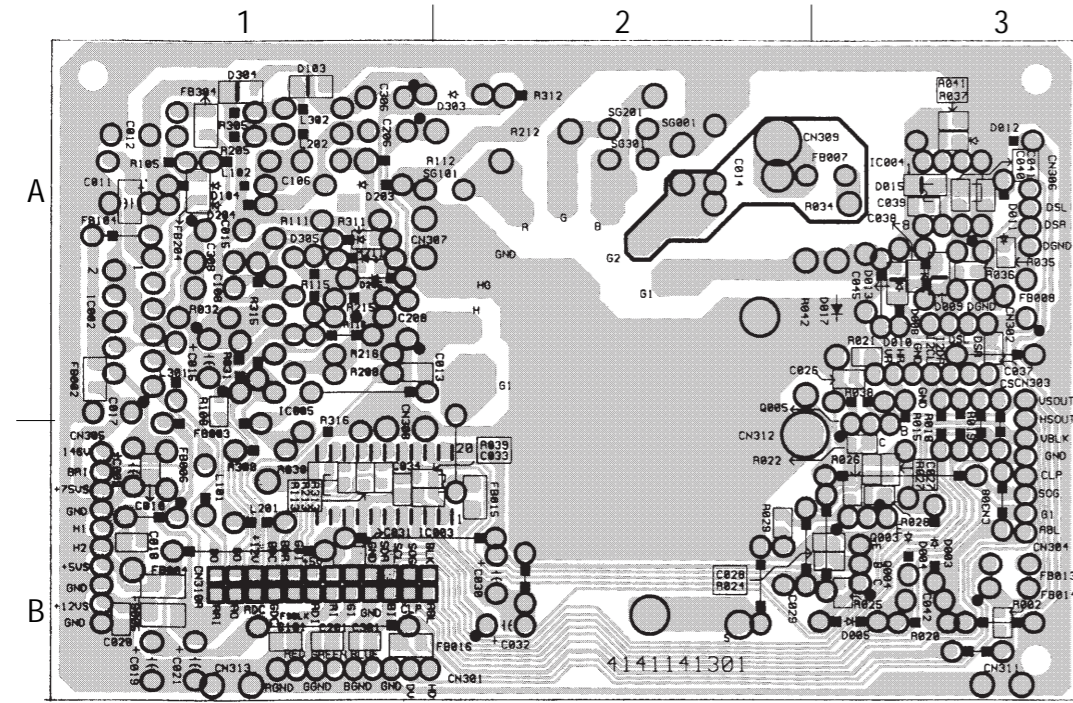

• A BOARD SEMICONDUCTOR LOCATION

IC		
	(Conductor Side)	(Component Side)
IC001	C-1	C-1
IC002	A-1	A-3
IC003	B-1	B-2
IC004	A-3	A-1
IC005	A-1	A-3

TRANSISTOR		
	(Conductor Side)	(Component Side)
Q001	C-1	C-1
Q002	C-1	C-1
Q003	B-3	B-1
Q004	B-3	B-1
Q005	B-3	B-1
Q007	C-1	C-1
Q008	C-1	C-1

DIODE		
	(Conductor Side)	(Component Side)
D002	C-1	
D003	B-3	B-1
D004	B-3	B-1
D005	B-3	B-1
D008	A-3	A-1
D009	A-3	
D010	A-3	A-1
D011	A-3	A-1
D012	A-3	A-1
D013	A-3	
D014	C-1	C-1
D016	C-1	
D017	A-3	A-1
D101	C-1	C-1
D102	C-1	C-1
D103	A-1	
D104	A-1	A-3
D105	A-1	A-2
D201	C-1	C-1
D202	C-1	C-1
D203	A-1	A-2
D204	A-1	A-3
D205	A-1	A-2
D301	C-1	
D302	C-1	
D303	A-2	A-2
D304	A-1	
D305	A-1	A-2



— A BOARD (Component Side) —

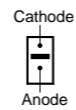

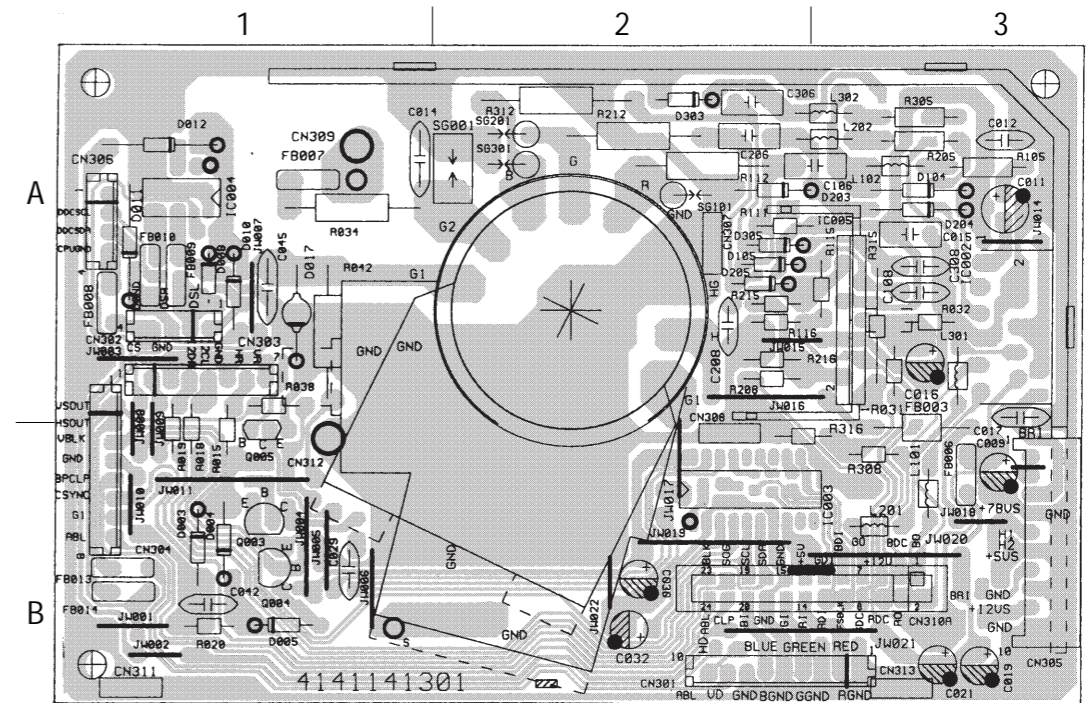
• Pattern of the rear side.

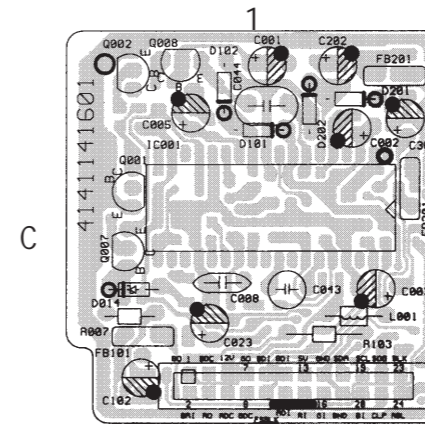
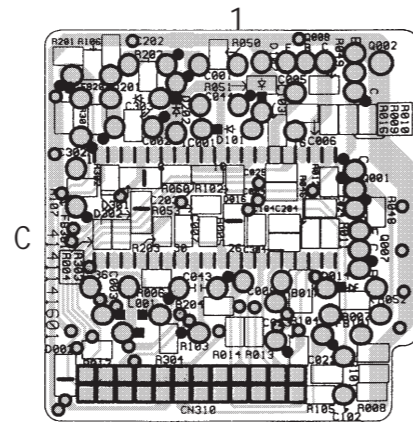

**NOTE:**  
The circuit indicated as left contains high voltage of over 600 Vp-p. Care must be paid to prevent an electric shock in inspection or repairing.

(3) Schematic Diagram of D (a-c) / D (USB) Boards

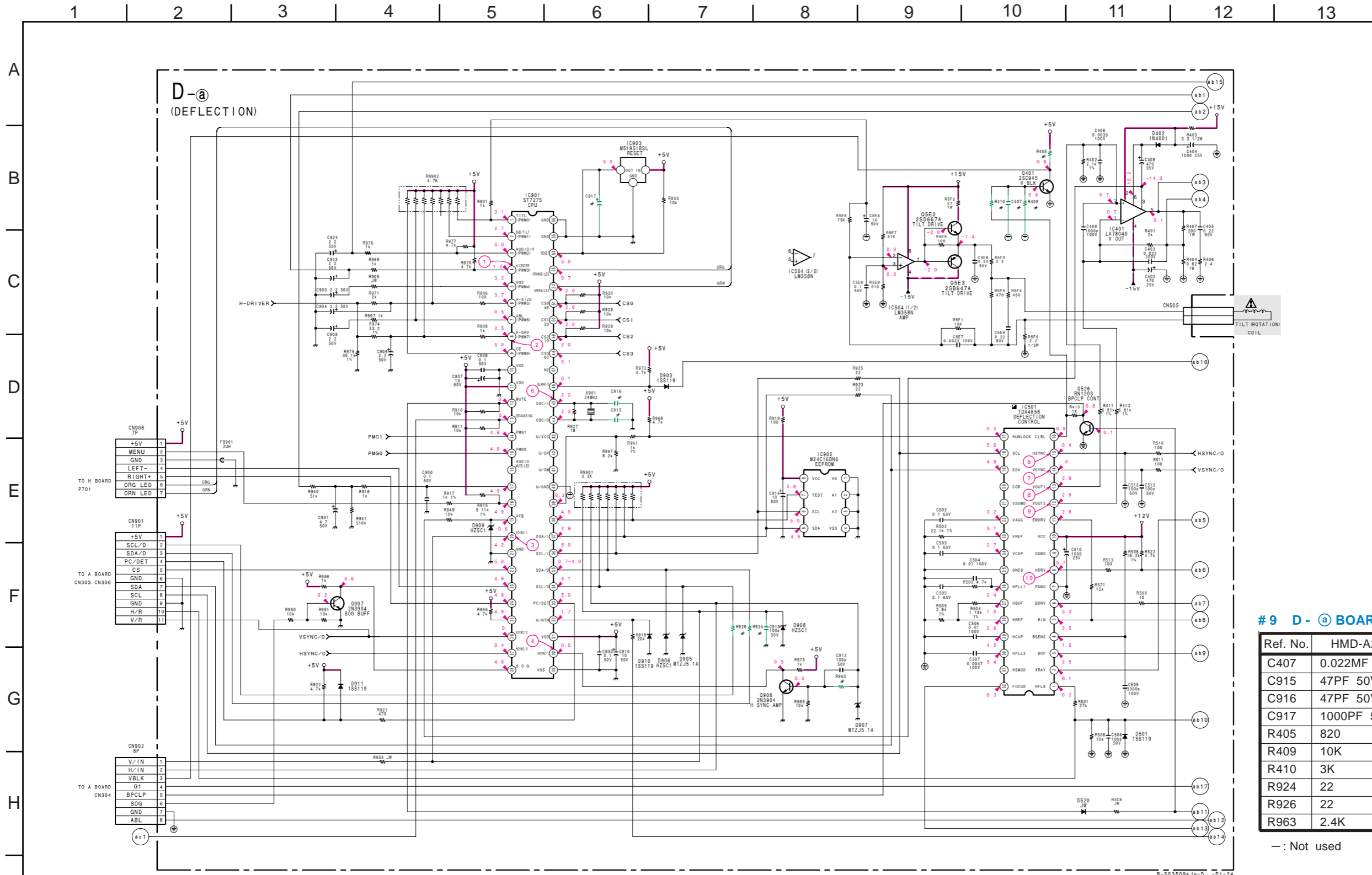

# 9 D - a BOARD \* MARKS LIST

Ref. No.	HMD-A200	HMD-A220
C407	0.022MF 100V	0.01MF 100V
C915	47PF 50V	22PF 50V
C916	47PF 50V	22PF 50V
C917	1000PF 50V	2.2MF 50V
R405	820	590 1%
R409	10K	5.49K 1%
R410	3K	2.2K
R924	22	—
R926	22	—
R963	2.4K	4.7K

— : Not used

• Divided circuit diagram  
 One sheet of D board circuit diagram is divided into three sheets, each having the code D-a to D-c. For example, the destination (ab1) on the D-a sheet is connected to (ab1) on the D-b sheet.

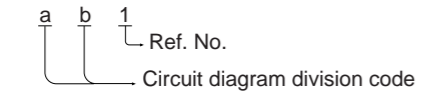

• D - a BOARD WAVEFORMS

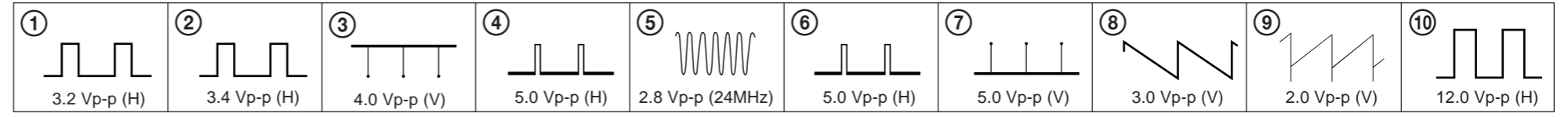

Schematic diagram  
 D - a board →

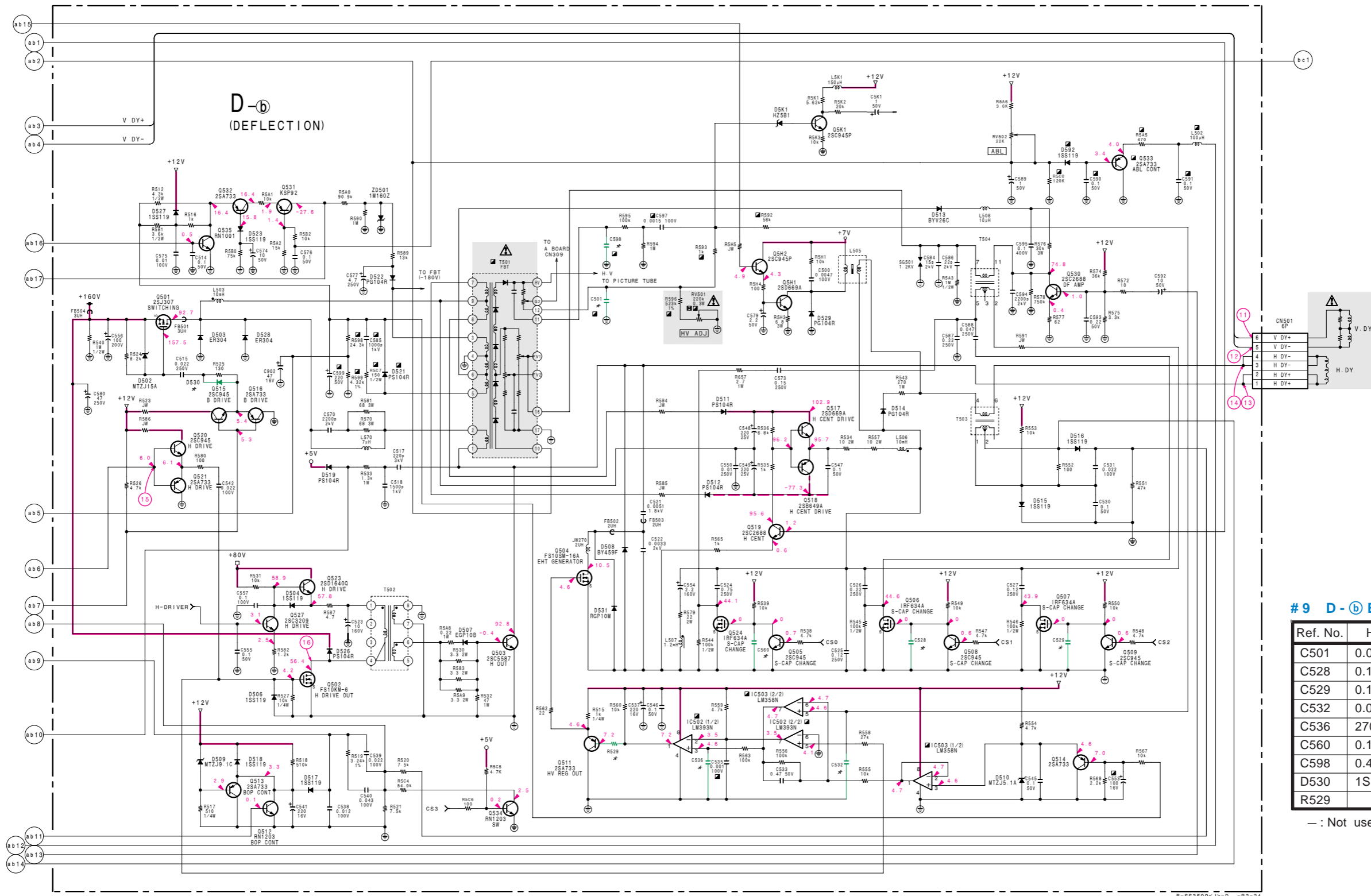

# 9 D - (b) BOARD \* MARKS LIST

Ref. No.	HMD-A200	HMD-A220
C501	0.015MF 100V	0.01MF 100V
C528	0.1MF 50V	-
C529	0.1MF 50V	-
C532	0.001F 100V	6800PF 100V
C536	2700PF 50V	3300PF 50V
C560	0.1MF 50V	0.0047MF 100V
C598	0.47MF 100V	0.33MF 100V
D530	1SS119	-
R529	-	470 1/4W

- : Not used

• Divided circuit diagram  
 One sheet of D board circuit diagram is divided into three sheets, each having the code D-ⓐ to D-ⓐ. For example, the destination ⓐ1 on the D-ⓐ sheet is connected to ⓐ1 on the D-ⓐ sheet.

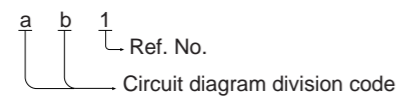

• D - (b) BOARD WAVEFORMS



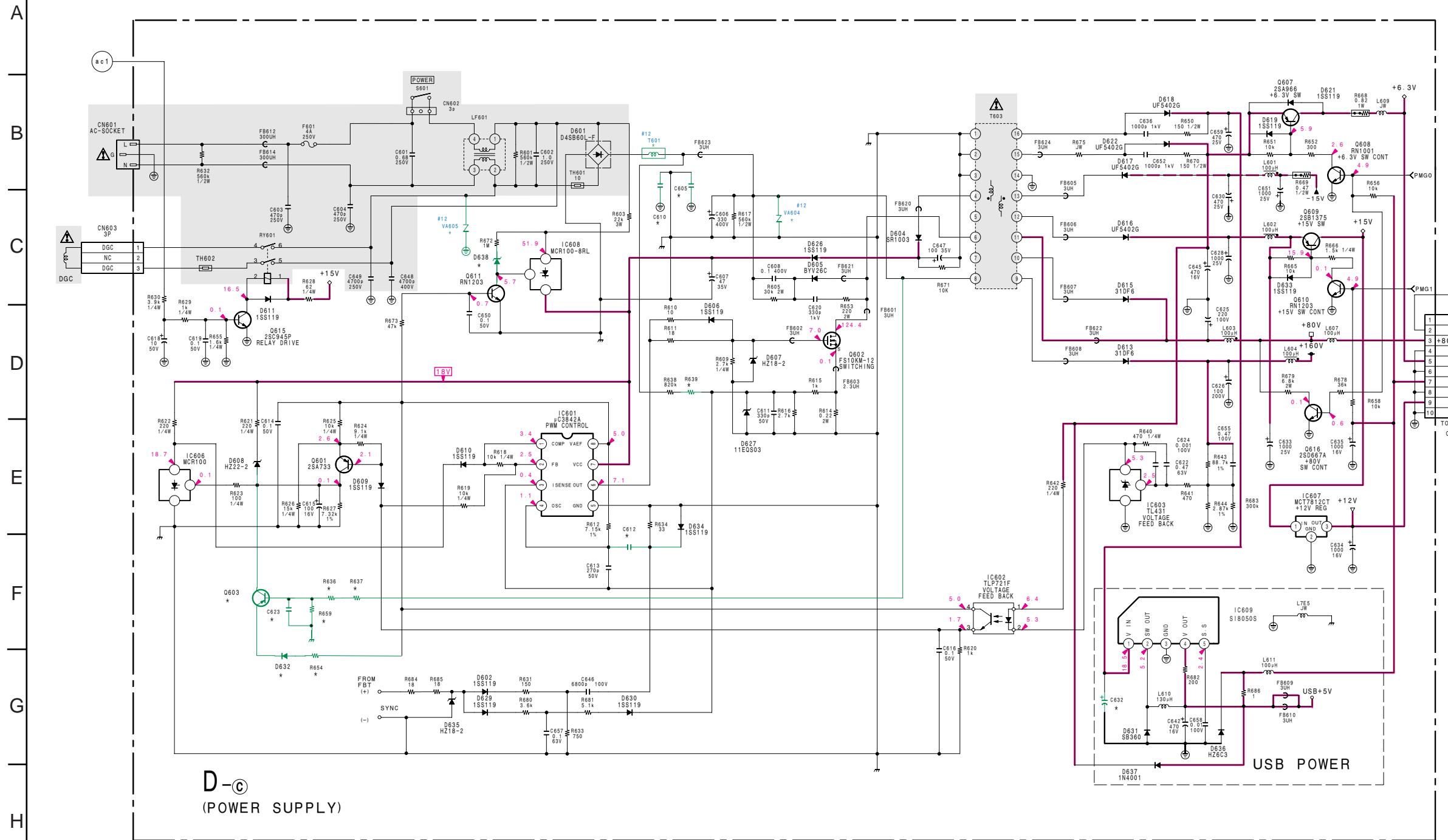

**D-(C)**  
(POWER SUPPLY)

**#9 D-(C) BOARD \* MARKS LIST**

Ref. No.	HMD-A200	HMD-A220
C605	4700PF 400V	4700PF 250V
C610	4700PF 400V	4700PF 250V
C612	0.1MF 100V	0.01MF 100V
C623	-	0.1MF 50V
C632	1000MF 25V	2200MF 25V
D632	-	1N4148
D638	-	Z160-B
Q603	-	2SA733
R636	-	240K 1%
R637	-	240K 1%
R639	820K	1M
R654	-	2K
R659	-	11K 1%

- : Not used

• Divided circuit diagram  
One sheet of D board circuit diagram is divided into three sheets, each having the code D-ⓐ to D-ⓐ. For example, the destination (ab1) on the D-ⓐ sheet is connected to (ab1) on the D-ⓐ sheet.

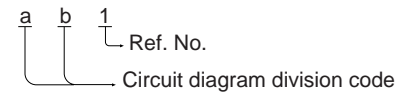

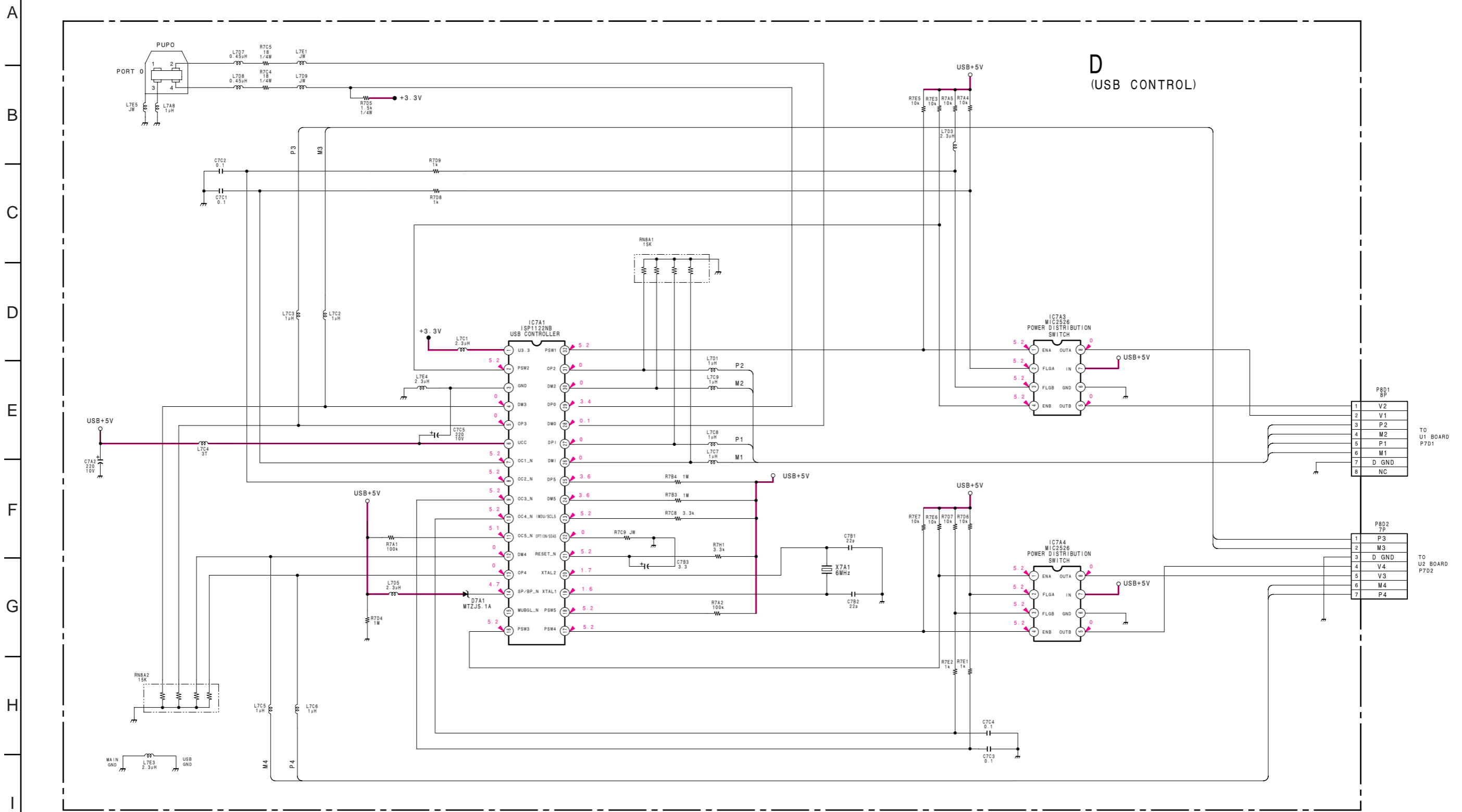

**D**

[ DEDFLECTION, POWER SUPPLY, USB CONTROL ]

— D BOARD —

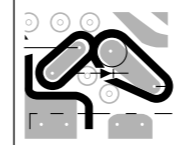
**NOTE:**

The circuit indicated as left contains high voltage of over 600 Vp-p. Care must be paid to prevent an electric shock in inspection or repairing.

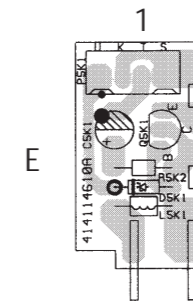
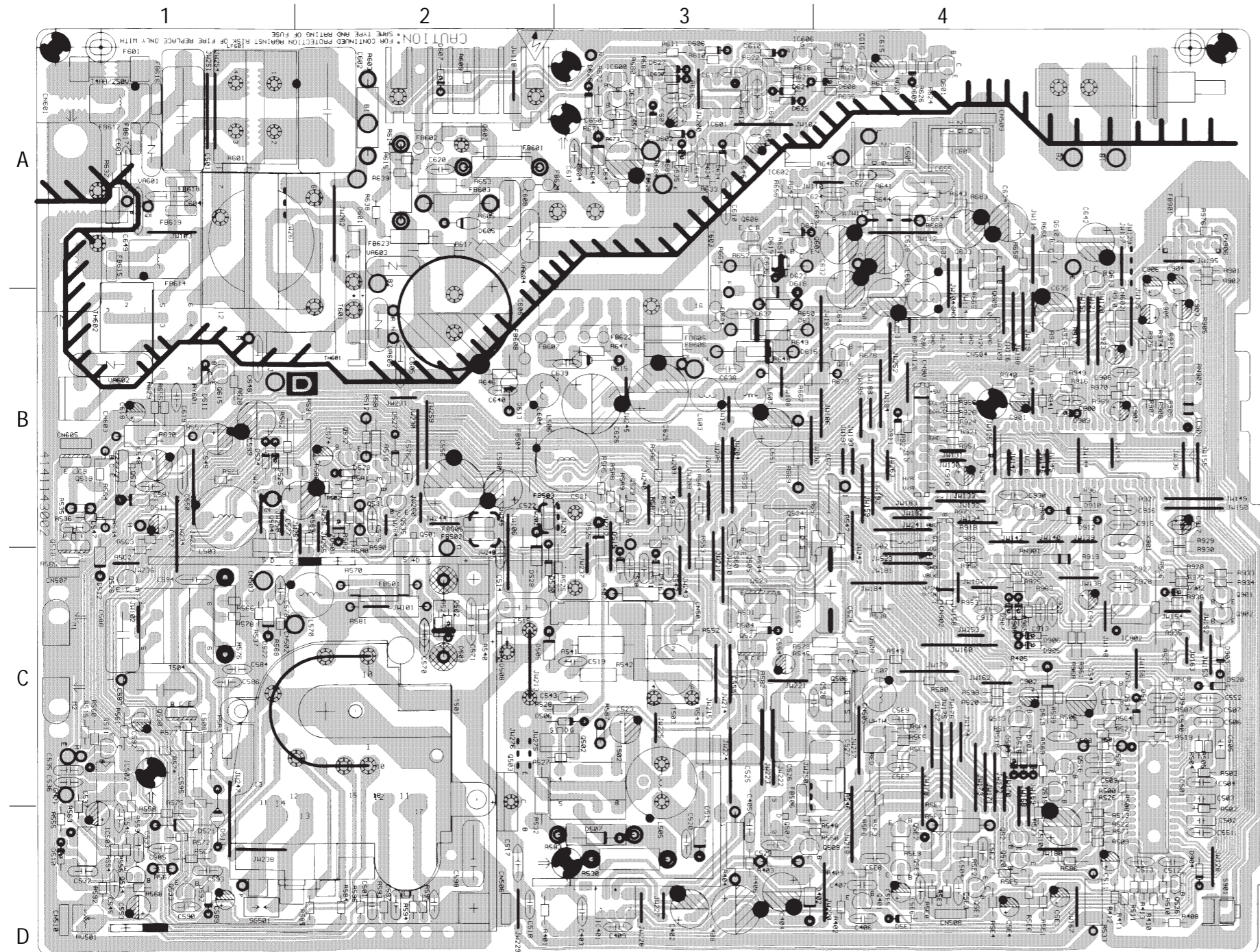

## • D BOARD

**SEMICONDUCTOR LOCATION**

IC	D504	C-3
	D506	D-3
	D507	D-3
	D508	C-2
	D509	C-4
	D510	C-1
	D511	C-1
	D512	C-1
	D513	D-1
	D514	C-3
	D515	B-3
	D516	B-3
	D517	C-4
	D518	C-4
	D519	C-4
	D521	D-1
	D522	C-2
	D523	B-2
	D526	C-2
	D527	B-2
	D528	C-2
	D529	C-3
	D530	B-2
	D531	B-2
	D592	D-1
	D5K1	E-1
	D601	A-2
	D602	A-3
	D604	A-3
	D605	A-2
	D606	A-3
	D607	A-2
	D608	A-3
	D609	A-3
	D610	A-3
	D611	B-2
	D613	B-2
	D615	B-2
	D616	B-3
	D617	B-3
	D618	B-3
	D619	A-3
	D621	A-3
	D622	A-3
	D626	A-3
	D627	A-3
	D629	A-3
	D630	A-3
	D631	A-4
	D633	A-4
	D634	A-3
	D635	A-3
	D636	A-4
	D637	A-4
	D7A1	D-4
	D903	C-4
	D905	C-4
	D906	C-4
	D907	C-4
	D908	C-4
	D909	B-4
	D910	B-4
	D911	B-4
	ZD501	C-2
	<b>VARIABLE RESISTOR</b>	
	RV501	D-1
	RV502	C-1
	<b>CRYSTAL</b>	
	X7A1	D-4
	X901	B-4
<b>DIODE</b>		
D402	D-3	
D501	C-4	
D502	C-2	
D503	C-2	



(3) Schematic Diagram of H Board

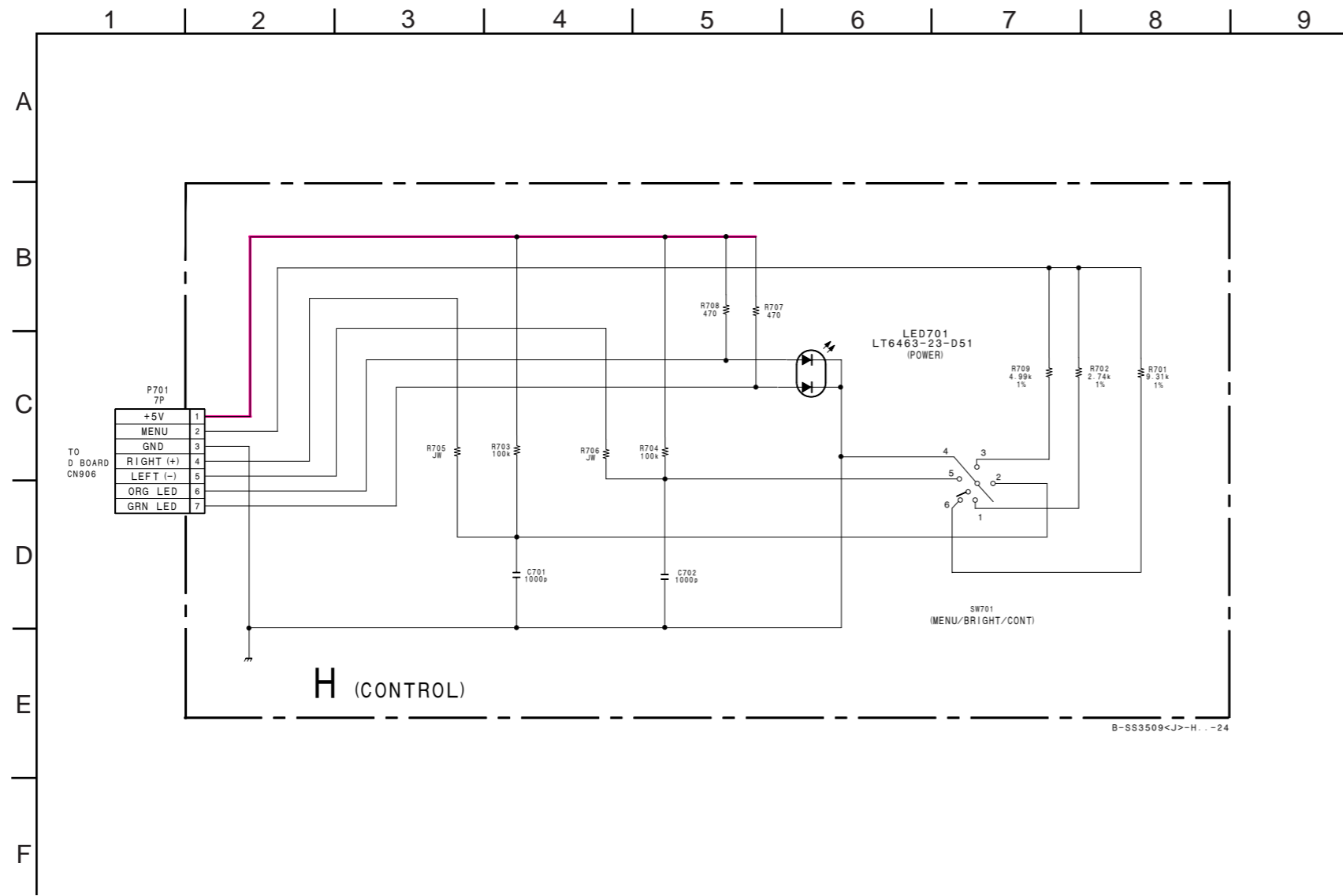

**H** [USER CONTROL, LED]

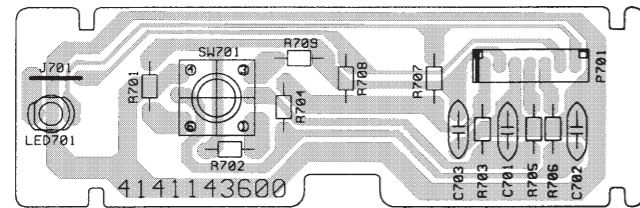

## 5-4. SEMICONDUCTORS

LA78040

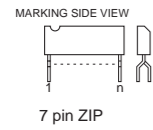

PC123F2

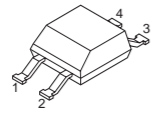

2N3904

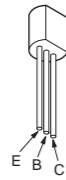

2SJ307-CB14

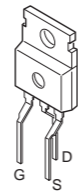

ER106  
HZ18-2  
HZ22-2  
HZ5C2  
MTZJ-T-73-15A  
PG104R  
SB140  
SB360  
SR1003  
UF5402G  
1N4001  
1N4148  
10E2  
11DQ03  
31DF6

LM2409

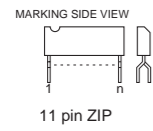

ST7275

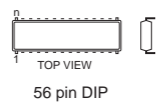

2SA1221-L  
2SC3209LK



BAV20  
MTZJ-3.6A  
MTZJ-5.1A  
RD5.1ESB2  
1SS119-25  
1SS227

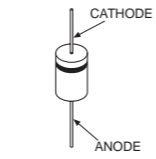
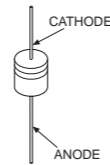

LM358N  
LM393N  
MIC2526-2BN  
M24C16BN6  
uC3842A  
24LC21/P

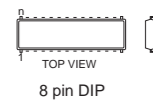

TDA4856

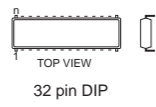

2SA733-Q  
2SC945-P

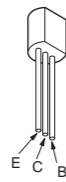

BYV26C

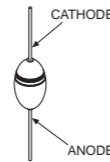

LT6463-23-D51

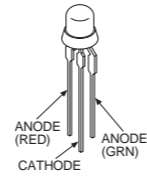

MCT7812CT

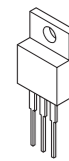

TDA6103Q

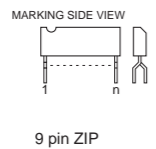

2SB647A  
2SC2688-LK  
2SD1640Q,R  
2SD667A-C  
2SD669AVC

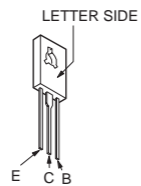

BY459F-1500

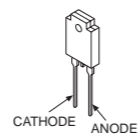

M35045-160SP

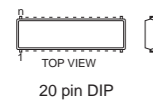

DTC124ESA  
RN1203

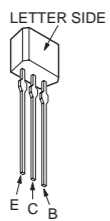

D4SB60L

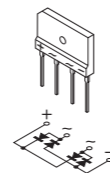

M51951BSL



FS10KM-6  
FS10KM-12  
FS7KM-16A



2SC2383-O

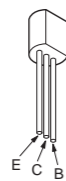

M52743BSP

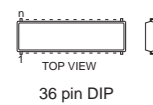

MCR100

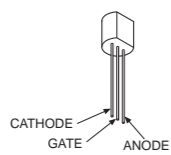

## SECTION 6 EXPLODED VIEWS

**NOTE:**

- Items with no part number and no description are not stocked because they are seldom required for routine service.
- The construction parts of an assembled part are indicated with a collation number in the remark column.
- Items marked " \* " are not stocked since they are seldom required for routine service. Some delay should be anticipated when ordering these items.

The components identified by mark  $\Delta$  are critical for safety. Replace only with part number specified.

Les composants identifiés par une marque  $\Delta$  sont critiques pour la sécurité. Ne les remplacer que par une pièce portant le numéro spécifié.

**6-1. CHASSIS**

●	7-685-648-79	+BVTP 3X12	8418113012
■	7-685-663-71	+BVTP 4X16	8418114016
◆	7-685-881-09	+BVTT 4X8	8121114008
○	7-685-648-71	+BVTP 3X10	8418113010

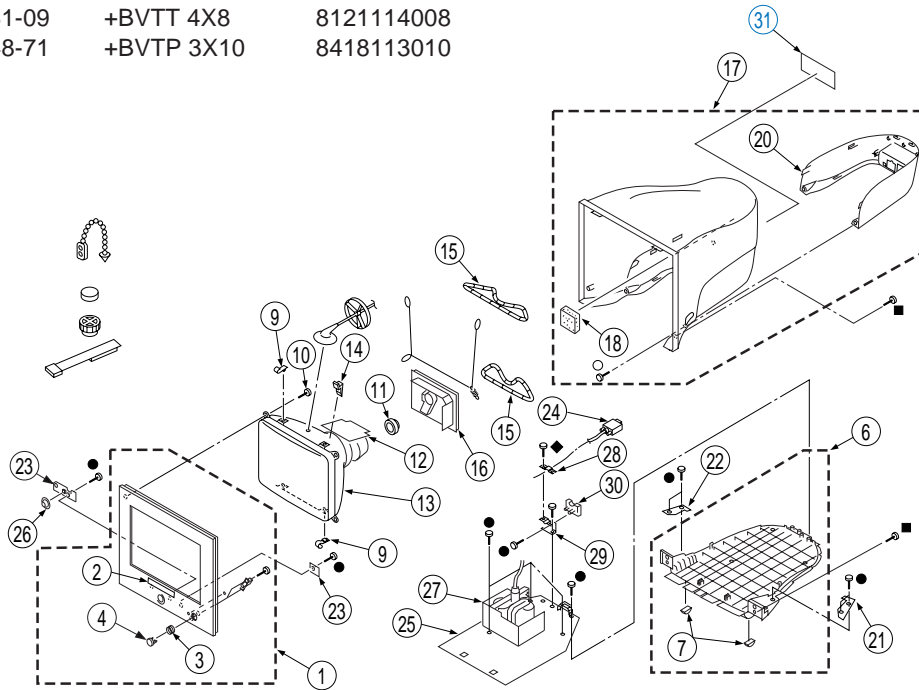

REF.NO.	PART NO.	DESCRIPTION	REMARK	REF.NO.	PART NO.	DESCRIPTION	REMARK
	1	X-4037-357-1 BEZEL ASSY(Natural Green)	2-4 GP7R516501	#6 17	X-4038-447-1 BUCKET ASSY(VAIO color)	18,20 GP7R5P7002	
#11	1	X-4039-027-1 BEZEL ASSY(VAIO color)[without VAIO logo]	2-4 GP7R5V7001	#8 17	X-4038-208-1 BUCKET ASSY(HMD-A220)	18,20 GP7R6U7002	
#10	1	X-4038-207-1 BEZEL ASSY(HMD-A220)	2-4 GP7R6U7001	18	4-073-622-01 SPONGE	9010099H10	
	2	4-042-353-21 EMBLEM (NO. 7), SONY	9009097T10	#2 19	4-073-621-01 GAP, TOP	1Q340B7R54	
	3	4-060-162-01 SPRING, COMPRESSION	2011097M10	20	4-073-623-01 COVER, DECO(Natural Green)	1Q260E7R51	
	4	4-073-612-01 KNOB, POWER(Natural Green)	1QA70F7R51	#6 20	4-073-623-21 COVER, DECO(VAIO color)	1Q260D7R51	
#6	4	4-073-975-11 KNOB, POWER(VAIO color)	1QA7055R5P	#8 20	4-073-623-11 COVER, DECO(HMD-A220)	1Q260H7R51	
#8	4	4-073-612-11 KNOB, POWER(HMD-A220)	1QA70R5R51	21	* A-1373-788-A U1 BOARD, COMPLETE		
#2	5	4-073-614-01 LENS	1M14005R51	22	* A-1373-789-A U2 BOARD, COMPLETE		
6	X-4037-358-1	COVER ASSY, BOTTOM(Natural Green)	7 GP7R516801	23	* A-1372-753-A H BOARD, COMPLETE		
#6	6	X-4038-449-1 COVER ASSY, BOTTOM(VAIO color)	7 GP7R5P7004	24	1-792-033-11 CABLE, I/O	C7105R5010	
#8	6	X-4038-209-1 COVER ASSY, BOTTOM(HMD-A220)	7 GP7R6U7004	25	* A-1343-774-A D BOARD, COMPLETE(HMD-A200)		
7	4-073-615-01	FOOT(Natural Green, HMA-A220)	9004097R51	#8 25	* A-1343-944-A D BOARD, COMPLETE(HMD-A220)	TU7R6U0144	
#6	7	4-073-615-11 FOOT(VAIO color)	9004097R51	26	4-073-619-01 KNOB, MENU(Natural Green)	1QA00E5R51	
#2	8	4-073-614-01 BOTTOM COVER	1Q030B7R51	#6 26	4-073-619-11 KNOB, MENU(VAIO color)	1QA0055R5P	
9	4-045-123-01	HOLDER, DEGAUSSING COIL	3682315Y11	#8 26	4-073-619-21 KNOB, MENU(HMD-A220)	1QA0035R51	
10	4-365-808-01	SCREW (5), TAPPING	8513145025	27	$\Delta$ 1-453-321-11 TRANSFOR MER, FLYBACK	7050307R50	
11	$\Delta$ 1-452-923-21	NECK ASSEMBLY	7047R50000	28	* 4-060-151-01 STOPPER, CABLE	2017095Y11	
#15	$\Delta$ 8-451-356-52	DEFLECTION YOKE (Y17TKJ2-M3)		29	* 4-060-150-01 BRACKET, CABLE	2003097R51	
13	8-738-558-05	PICTURE TUBE 17TKB	7010040717	30	4-073-616-01 HOLDER, CABLE(Natural Green)	1Q500E7R51	
14	4-060-166-01	SPACER, DY	3090007Y11	#6 30	4-073-616-21 HOLDER, CABLE(VAIO color)	1Q500D7R51	
15	$\Delta$ 1-416-282-21	COIL, DEMAGNETIC	7020177R50	#8 30	4-073-616-11 HOLDER, CABLE(HMD-A220)	1Q500D7R51	
16	* A-1294-889-A	A BOARD, COMPLETE		#5 31	4-072-544-01 LABEL, INFORMATION (U/C)(Natural Green)	9011097R51	
17	X-4037-356-1	BUCKET ASSY(Natural Green)	18,20 GP7R517501	#6 31	4-072-544-11 LABEL, INFORMATION (U/C)(VAIO color)	9011097R5V	
				#5 31	4-073-454-01 LABEL, INFORMATION (AEP)	9011097R6E	
				#8 31	4-073-454-11 LABEL, INFORMATION (HMD-A220)	9011097R6U	

6-2. PACKING MATERIALS

The components identified by mark  $\triangle$  are critical for safety. Replace only with part number specified.

Les composants identifiés par une marque  $\triangle$  sont critiques pour la sécurité. Ne les remplacer que par une pièce portant le numéro spécifié.

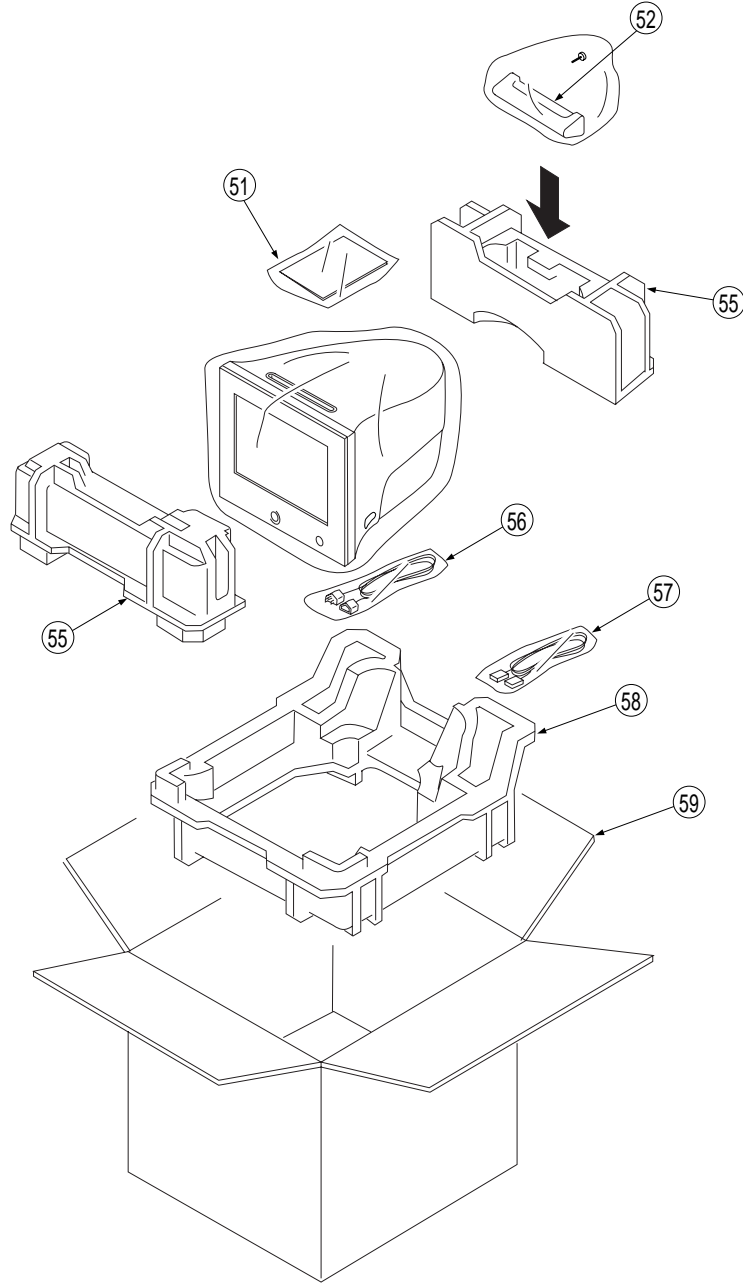

REF.NO.	PART NO.	DESCRIPTION	REMARK	REF.NO.	PART NO.	DESCRIPTION	REMARK
	51	3-867-863-11	MANUAL, INSTRUCTION (U/C)	9012095R52			
	51	3-867-863-21	MANUAL, INSTRUCTION (AEP)	9012095R6E			
#8	51	4-078-615-11	MANUAL, INSTRUCTION (HMD-A220)	9012095R6U			
	52	X-4037-359-1	STAND ASSY(Natural Green)	GP5R516901			
#6	52	X-4037-741-1	STAND ASSY(VAIO color)	GP5R5P7503			
#8	52	X-4038-210-1	STAND ASSY(HMD-A220)	GP7R6U7003			
#2	53	4-073-617-04	STAND	4HAP0B5R54			
#2	54	7-685-663-74	SCREW+BVTP-4X12-TYPE2-IT-3	8026144012			
	55	* 4-073-792-01	CUSHION (UPPER) (ASSY)	9001097R51			
	56	$\triangle$ 1-776-027-41	CORD SET, POWER (U/C)	4635R5101R			
	56	$\triangle$ 1-765-719-11	CORD SET, POWER (AEP)	4635R6E01N			
	57	1-792-032-11	CABLE, USB	C7117R1010			
	58	* 4-073-793-01	CUSHION (LOWER)	9003097R51			
	59	* 4-072-600-01	INDIVIDUAL CARTON (U/C)	9001097R51			
	59	4-073-806-01	INDIVIDUAL CARTON (AEP)	9001097R53			
#9	59	4-079-001-01	INDIVIDUAL CARTON (HMD-A220)	9001097R6U			

## SECTION 6

### ELECTRICAL PARTS LIST

#### NOTE:

The components identified  $\triangle$  marked are critical for safety.  
Replace only with the part number specified.

Les composants identifiés par la marque  $\triangle$  sont critiques pour la sécurité.  
Ne les remplacer que par une pièce portant le numéro spécifié.

When indicating parts by reference number, please include the board name.

The components identified by  $\boxtimes$  in this manual have been carefully factory-selected for each set in order to satisfy regulations regarding X-ray radiation. Should replacement be required, replace only with the value originally used.

- All variable and adjustable resistors have characteristic curve B, unless otherwise noted.

- Items marked " \* " are not stocked since they are seldom required for routine service. Some delay should be anticipated when ordering these items.

#### RESISTORS

- All resistors are in ohms
- F : nonflammable

No.	#	Board	Type	△/*	Ref.No.	Part No.	Descrption	Remarks-1	Remarks-2	Difference
1		A	SOCKET, CRT	△	J001	1-251-598-11	CRT SOCKET CVT3211-1392	4570307Y11		
2		A	CAPACITOR		C002	1-135-390-11	CAP-EC3 220UFM 16V DXL=6.3X11	5153221T16		
3		A	CAPACITOR		C003	1-135-393-11	CAP-EC6 100UFM 10V -RT-	5156101T10		
4		A	CAPACITOR		C004	1-164-489-91	CAP-X7R 0.22UFK 16V CHIP 0805	7144224106		
5		A	CAPACITOR		C005	1-135-397-11	CAP-ECX 47UFM 16V -RT-	515X470T16		
6		A	CAPACITOR		C006	1-115-339-91	CAP-Y5V 0.1UFZ 50V CHIP 0805	7146104456		
7		A	CAPACITOR		C008	1-136-497-11	CAP-SCF 0.1UFZ 50V -RT-	5134104452		
8		A	CAPACITOR		C009	1-104-660-91	CAP-EC6 47UFM 16V 5X11 -RT-	5156470T16		
9		A	CAPACITOR		C010	1-115-339-91	CAP-Y5V 0.1UFZ 50V CHIP 0805	7146104456		
10		A	CAPACITOR		C011	1-128-582-91	CAP-EC6 10UFM 100V -RT-	5156100T01		
11		A	CAPACITOR		C012	1-135-383-11	CAP-MEF 0.1UFJ 100V CF	5075104501		
12		A	CAPACITOR		C013	1-115-339-91	CAP-Y5V 0.1UFZ 50V CHIP 0805	7146104456		
13		A	CAPACITOR		C014	1-161-731-81	CAP-CCR 1000PFK 2KV P:7.5MM -S	510H1021C3		
14		A	CAPACITOR		C015	1-135-383-11	CAP-MEF 0.1UFJ 100V CF	5075104501		
15		A	CAPACITOR		C016	1-135-395-11	CAP-EC6 4.7UFM 50V 5X11 -RT-	5156479T50		
16		A	CAPACITOR		C017	1-135-383-11	CAP-MEF 0.1UFJ 100V CF	5075104501		
17		A	CAPACITOR		C018	1-115-339-91	CAP-Y5V 0.1UFZ 50V CHIP 0805	7146104456		
18		A	CAPACITOR		C019	1-135-393-11	CAP-EC6 100UFM 10V -RT-	5156101T10		
19		A	CAPACITOR		C020	1-115-339-91	CAP-Y5V 0.1UFZ 50V CHIP 0805	7146104456		
20		A	CAPACITOR		C021	1-104-660-91	CAP-EC6 47UFM 16V 5X11 -RT-	5156470T16		
21		A	CAPACITOR		C022	1-163-682-91	CAP-COG 560PFJ 50V CHIP 0805	7183561556		
22		A	CAPACITOR		C023	1-135-393-11	CAP-EC6 100UFM 10V -RT-	5156101T10		
23		A	CAPACITOR		C024	1-115-339-91	CAP-Y5V 0.1UFZ 50V CHIP 0805	7146104456		
24		A	CAPACITOR		C025	1-115-339-91	CAP-Y5V 0.1UFZ 50V CHIP 0805	7146104456		
25		A	CAPACITOR		C026	1-163-013-11	CAP-X7R 2200PFK 50V CHIP 0805	7144222156		
26		A	CAPACITOR		C028	1-115-339-91	CAP-Y5V 0.1UFZ 50V CHIP 0805	7146104456		
27		A	CAPACITOR		C029	1-102-074-11	CAP-CCB 1000PFK 50V -RT-	5101102152		
28		A	CAPACITOR		C030	1-135-393-11	CAP-EC6 100UFM 10V -RT-	5156101T10		
29		A	CAPACITOR		C031	1-115-339-91	CAP-Y5V 0.1UFZ 50V CHIP 0805	7146104456		
30		A	CAPACITOR		C032	1-135-398-11	CAP-EC6 1UFM 50V 6.3X11 -RT-	5156109T50		
31		A	CAPACITOR		C033	1-163-013-11	CAP-X7R 2200PFK 50V CHIP 0805	7144222156		

No.	#	Board	Type	△/*	Ref.No.	Part No.	Description	Remarks-1	Remarks-2	Difference
32		A	CAPACITOR		C034	1-115-339-91	CAP-Y5V 0.1UFZ 50V CHIP 0805	7146104456		
33		A	CAPACITOR		C037	1-115-339-91	CAP-Y5V 0.1UFZ 50V CHIP 0805	7146104456		
34		A	CAPACITOR		C038	1-115-339-91	CAP-Y5V 0.1UFZ 50V CHIP 0805	7146104456		
35		A	CAPACITOR		C039	1-115-339-91	CAP-Y5V 0.1UFZ 50V CHIP 0805	7146104456		
36		A	CAPACITOR		C040	1-163-259-11	CAP-COG 220PFJ 50V CHIP 0805	7183221556		
37		A	CAPACITOR		C041	1-163-259-11	CAP-COG 220PFJ 50V CHIP 0805	7183221556		
38		A	CAPACITOR		C042	1-135-354-11	CAP-CCB 180PFK 50V -RT-	5101181152		
39		A	CAPACITOR		C043	1-135-404-11	CAP-NP 4.7UFM 35V 5X11 -RT-	5162479T35		
40		A	CAPACITOR		C045	1-161-731-81	CAP-CCF 0.01UFZ 2KV -SF-	51041034C3		
41		A	CAPACITOR		C101	1-163-235-11	CAP-COG 22PFJ 50V CHIP 0805	7183220556		
42		A	CAPACITOR		C102	1-126-964-91	CAP-EC6 10UFM 50V 5X11 -RT-	5156100T50		
43		A	CAPACITOR		C103	1-115-339-91	CAP-Y5V 0.1UFZ 50V CHIP 0805	7146104456		
44		A	CAPACITOR		C104	1-115-339-91	CAP-Y5V 0.1UFZ 50V CHIP 0805	7146104456		
45		A	CAPACITOR		C106	1-135-383-11	CAP-MEF 0.1UFJ 100V CF	5075104501		
46		A	CAPACITOR		C108	1-135-383-11	CAP-MEF 0.1UFJ 100V CF	5075104501		
47		A	CAPACITOR		C201	1-163-235-11	CAP-COG 22PFJ 50V CHIP 0805	7183220556		
48		A	CAPACITOR		C202	1-126-964-91	CAP-EC6 10UFM 50V 5X11 -RT-	5156100T50		
49		A	CAPACITOR		C203	1-115-339-91	CAP-Y5V 0.1UFZ 50V CHIP 0805	7146104456		
50		A	CAPACITOR		C204	1-115-339-91	CAP-Y5V 0.1UFZ 50V CHIP 0805	7146104456		
51		A	CAPACITOR		C206	1-135-383-11	CAP-MEF 0.1UFJ 100V CF	5075104501		
52		A	CAPACITOR		C208	1-135-383-11	CAP-MEF 0.1UFJ 100V CF	5075104501		
53		A	CAPACITOR		C301	1-163-235-11	CAP-COG 22PFJ 50V CHIP 0805	7183220556		
54		A	CAPACITOR		C302	1-126-964-91	CAP-EC6 10UFM 50V 5X11 -RT-	5156100T50		
55		A	CAPACITOR		C303	1-115-339-91	CAP-Y5V 0.1UFZ 50V CHIP 0805	7146104456		
56		A	CAPACITOR		C304	1-115-339-91	CAP-Y5V 0.1UFZ 50V CHIP 0805	7146104456		
57		A	CAPACITOR		C306	1-135-383-11	CAP-MEF 0.1UFJ 100V CF	5075104501		
58		A	CAPACITOR		C308	1-135-383-11	CAP-MEF 0.1UFJ 100V CF	5075104501		
59		A	COIL		FB007	1-419-444-11	COIL PEAKING 0.33uH SS-TYPE -A	432B338006		
60		A	COIL		JW017	1-419-444-11	COIL PEAKING 0.33uH SS-TYPE -A	432B338006		
61		A	COIL		L001	1-469-400-11	COIL PEAKING 100uH SS-TYPE-AT	432B101006		
62		A	COIL		L101	1-469-398-11	PEAKING COIL 0.1UH	432B108006		

No.	#	Board	Type	△/*	Ref.No.	Part No.	Description	Remarks-1	Remarks-2	Difference
63		A	COIL		L102	1-419-618-11	COIL PEAKING 0.47uH SS-TYPE	432B478006		
64		A	COIL		L201	1-469-398-11	PEAKING COIL 0.1UH	432B108006		
65		A	COIL		L202	1-419-616-11	COIL PEAKING 0.56UH SS-TYPE-	432B568006		
66		A	COIL		L301	1-469-398-11	PEAKING COIL 0.1UH	432B108006		
67		A	COIL		L302	1-469-399-11	COIL PEAKING 0.68UH SS-T	432B688006		
68		A	CONNECTOR	*	CN302	1-564-507-51	CONN. 4P 2.5mm W232V04T00	4490400330		
69		A	CONNECTOR	*	CN303	1-564-510-51	CONN. 7P WAFER 2.5MM	4490700330		
70		A	CONNECTOR	*	CN304	1-564-511-11	CONN. 8P 2.5mm W232V08T00	4490800330		
71		A	CONNECTOR	*	CN305	1-564-525-11	CONN. 10P 2.5MM 90 DEGREE	4491081000		
72		A	CONNECTOR	*	CN306	1-564-507-51	CONN. 4P 2.5mm W232V04T00	4490400330		
73		A	CONNECTOR	*	CN309	1-506-108-41	BEAD PIN 16.5X2.36mm	3340236016		
74		A	CONNECTOR	*	CN310	1-793-925-11	BASE PIN	4491202000		
75		A	CONNECTOR	*	CN311	1-695-915-11	CONTACT T=0.5 W=4.75MM	4490100209		
76		A	DIODE		D002	8-719-070-90	DIODE 1N4148 (BAS32L) MLF SMD	412014148T		
77		A	DIODE		D003	8-719-994-52	DIODE ZENER 5.1V HZ5C-2 -AT-	41205005C2		
78		A	DIODE		D004	8-719-921-20	DIODE 1SS119TD -AT-	4120511900		
79		A	DIODE		D005	8-719-921-20	DIODE 1SS119TD -AT-	4120511900		
80		A	DIODE		D008	8-719-921-20	DIODE 1SS119TD -AT-	4120511900		
81		A	DIODE		D009	8-719-070-90	DIODE 1N4148 (BAS32L) MLF SMD	412014148T		
82		A	DIODE		D010	8-719-921-20	DIODE 1SS119TD -AT-	4120511900		
83		A	DIODE		D011	8-719-921-20	DIODE 1SS119TD -AT-	4120511900		
84		A	DIODE		D012	8-719-921-20	DIODE 1SS119TD -AT-	4120511900		
85		A	DIODE		D013	8-719-070-90	DIODE 1N4148 (BAS32L) MLF SMD	412014148T		
86		A	DIODE		D014	8-719-982-03	DIODE ZENER MTZJ-3.6A	41205036AU		HMD-A200
87		A	DIODE		D016	8-719-070-90	DIODE 1N4148 (BAS32L) MLF SMD	412014148T		HMD-A200
88		A	DIODE		D017	8-719-074-13	DIODE BYV26C 1A/600V -AT-	413010426C		
89		A	DIODE		D101	8-719-921-20	DIODE 1SS119TD -AT-	4120511900		
90		A	DIODE		D102	8-719-921-20	DIODE 1SS119TD -AT-	4120511900		
91		A	DIODE		D103	8-719-070-90	DIODE 1N4148 (BAS32L) MLF SMD	412014148T		
92		A	DIODE		D104	8-719-074-15	DIODE BAV20 DO-35 -AT-	413258020U		
93		A	DIODE		D105	8-719-074-15	DIODE BAV20 DO-35 -AT-	413258020U		



No.	#	Board	Type	△/*	Ref.No.	Part No.	Description	Remarks-1	Remarks-2	Difference
94		A	DIODE		D201	8-719-921-20	DIODE 1SS119TD -AT-	4120511900		
95		A	DIODE		D202	8-719-921-20	DIODE 1SS119TD -AT-	4120511900		
96		A	DIODE		D203	8-719-074-15	DIODE BAV20 DO-35 -AT-	413258020U		
97		A	DIODE		D204	8-719-074-15	DIODE BAV20 DO-35 -AT-	413258020U		
98		A	DIODE		D205	8-719-074-15	DIODE BAV20 DO-35 -AT-	413258020U		
99		A	DIODE		D301	8-719-070-90	DIODE 1N4148 (BAS32L) MLF SMD	412014148T		
100		A	DIODE		D302	8-719-070-90	DIODE 1N4148 (BAS32L) MLF SMD	412014148T		
101		A	DIODE		D303	8-719-074-15	DIODE BAV20 DO-35 -AT-	413258020U		
102		A	DIODE		D304	8-719-070-90	DIODE 1N4148 (BAS32L) MLF SMD	412014148T		
103		A	DIODE		D305	8-719-074-15	DIODE BAV20 DO-35 -AT-	413258020U		
104		A	FERRITE BEAD		FB002	1-500-104-21	FERRITE BEAD (SMD)	4328350006		
105		A	FERRITE BEAD		FB003	1-469-403-11	FERRITE BEAD 2UH -AT-	4322209046		
106		A	FERRITE BEAD		FB004	1-500-104-21	FERRITE BEAD (SMD)	4328350006		
107		A	FERRITE BEAD		FB005	1-500-104-21	FERRITE BEAD (SMD)	4328350006		
108		A	FERRITE BEAD		FB006	1-412-911-11	FERRITE BEAD 2.3UH	7099159250		
109		A	FERRITE BEAD		FB008	1-412-911-11	FERRITE BEAD 2.3UH	7099159250		
110		A	FERRITE BEAD		FB009	1-412-911-11	FERRITE BEAD 2.3UH	7099159250		
111		A	FERRITE BEAD		FB010	1-412-911-11	FERRITE BEAD 2.3UH	7099159250		
112		A	FERRITE BEAD		FB013	1-412-911-11	FERRITE BEAD 2.3UH	7099159250		
113		A	FERRITE BEAD		FB014	1-412-911-11	FERRITE BEAD 2.3UH	7099159250		
114		A	FERRITE BEAD		FB015	1-500-104-21	FERRITE BEAD (SMD)	4328350006		
115		A	FERRITE BEAD		FB016	1-500-104-21	FERRITE BEAD (SMD)	4328350006		
116		A	FERRITE BEAD		FB104	1-500-104-21	FERRITE BEAD (SMD)	4328350006		
117		A	FERRITE BEAD		FB204	1-500-104-21	FERRITE BEAD (SMD)	4328350006		
118		A	FERRITE BEAD		FB304	1-500-104-21	FERRITE BEAD (SMD)	4328350006		
119		A	IC		IC001	8-759-582-06	IC M52743BSP	4159527432		
120		A	IC		IC002	8-759-582-08	IC LM2409T	4159240900		
121		A	IC		IC003	8-759-654-38	IC. M35045-160SP	4159350454		
122		A	IC		IC004	8-759-399-78	IC 24LC21 8PIN	4159242100		
123		A	IC		IC005	8-759-434-40	IC TDA6103Q/N3.112	4159610300		
124		A	RESISTOR		R002	1-216-025-91	RES-CHIP 1/10W J 100R 0805	4010110152		

No.	#	Board	Type	△/*	Ref.No.	Part No.	Description	Remarks-1	Remarks-2	Difference
125		A	RESISTOR		R004	1-216-025-91	RES-CHIP 1/10W J 100R 0805	4010110152		
126		A	RESISTOR		R005	1-216-049-91	RES-CHIP 1/10W J 1K 0805	4010110252		
127		A	RESISTOR		R006	1-216-073-91	RES-CHIP 1/10W J 10K 0805	4010110352		
128		A	RESISTOR		R007	1-247-807-91	RES-CF 1/4W J 100R -AT- SMALL	4050510155		
129		A	RESISTOR		R008	1-216-057-91	RES-CHIP 1/10W J 2.2K 0805	4010122252		
130		A	RESISTOR		R008	1-216-057-91	RES-CHIP 1/10W J 2.2K 0805	4010122252		
131		A	RESISTOR		R009	1-216-049-91	RES-CHIP 1/10W J 1K 0805	4010110252		
132		A	RESISTOR		R010	1-216-025-91	RES-CHIP 1/10W J 100R 0805	4010110152		
133		A	RESISTOR		R011	1-216-037-11	RES-CHIP 1/10W J 330R 0805	4010133152		
134		A	RESISTOR		R013	1-216-065-11	RES-CHIP 1/10W J 4.7K 0805	4010147252		
135		A	RESISTOR		R014	1-216-065-11	RES-CHIP 1/10W J 4.7K 0805	4010147252		
136		A	RESISTOR		R015	1-247-816-91	RES-CF 1/4W J 240R SMALL -AT-	4050524155		
137		A	RESISTOR		R016	1-216-060-91	RES-CHIP 1/10W J 3K 0805	4010130252		
138		A	RESISTOR		R018	1-247-807-91	RES-CF 1/4W J 100R -AT- SMALL	4050510155		
139		A	RESISTOR		R019	1-247-807-91	RES-CF 1/4W J 100R -AT- SMALL	4050510155		
140		A	RESISTOR		R020	1-247-838-91	RES-CF 1/4W J 2K -AT- SMALL	4050520255		
141		A	RESISTOR		R021	1-216-073-91	RES-CHIP 1/10W J 10K 0805	4010110352		
142		A	RESISTOR		R022	1-216-057-91	RES-CHIP 1/10W J 2.2K 0805	4010122252		
143		A	RESISTOR		R024	1-216-049-91	RES-CHIP 1/10W J 1K 0805	4010110252		
144		A	RESISTOR		R025	1-216-034-91	RES CHIP 1/10W J 240R	4010124152		
145		A	RESISTOR		R026	1-216-042-11	RES-CHIP 1/10W J 510R 0805 -AT	4010151152		
146		A	RESISTOR		R027	1-216-049-91	RES-CHIP 1/10W J 1K 0805	4010110252		
147		A	RESISTOR		R028	1-216-049-91	RES-CHIP 1/10W J 1K 0805	4010110252		
148		A	RESISTOR		R029	1-216-053-11	RES-CHIP 1/10W J 1.5K 0805	4010115252		
149		A	RESISTOR		R030	1-216-073-91	RES-CHIP 1/10W J 10K 0805	4010110352		
150		A	RESISTOR		R031	1-247-859-91	RES-CF 1/4W J 15K -AT- SMALL	4050515355		
151		A	RESISTOR		R032	1-247-848-91	RES-CF 1/4W J 5.1K -AT- SMALL	4050551255		
152		A	RESISTOR		R034	1-243-475-11	RES-CC 1/2W K 51K -AT-	4060251315		
153		A	RESISTOR		R035	1-216-017-11	RES-CHIP 1/10W J 47R 0805	4010147052		
154		A	RESISTOR		R036	1-216-017-11	RES-CHIP 1/10W J 47R 0805	4010147052		
155		A	RESISTOR		R037	1-216-065-11	RES-CHIP 1/10W J 4.7K 0805	4010147252		

No.	#	Board	Type	△/*	Ref.No.	Part No.	Description	Remarks-1	Remarks-2	Difference
156		A	RESISTOR		R039	1-216-058-11	RES-CHIP 1/10W F 2.4K 0805	4010124202		
157		A	RESISTOR		R042	1-202-818-00	RES-CC 1/2W K 1K -AT-	4060210215		
158		A	RESISTOR		R046	1-216-049-91	RES-CHIP 1/10W J 1K 0805	4010110252		
159		A	RESISTOR		R101	1-216-022-11	RES-CHIP 1/10W F 75R 0805	4010175002		
160		A	RESISTOR		R102	1-216-060-91	RES-CHIP 1/10W F 33R 0805	4010133002		
161		A	RESISTOR		R103	1-247-831-91	RES-CF 1/4W J 1K -AT- SMALL	4050510255		
162		A	RESISTOR		R104	1-216-025-91	RES-CHIP 1/10W J 100R 0805	4010110152		
163		A	RESISTOR		R105	1-243-653-11	RES-CF 1/2WSS J 68R -AT-W=52mm	4050168055		
164		A	RESISTOR		R108	1-216-679-91	RES-CHIP 1/10W J 15K 0805	4010115352		
165		A	RESISTOR		R111	1-247-903-91	RES-CF 1/4W J 1M -AT- SMALL	4050510555		
166		A	RESISTOR		R112	1-202-553-91	RES-CC 1/2W K 150R -AT-	4060215115		
167		A	RESISTOR		R113	1-216-013-00	RES-CHIP 1/10W J 33R 0805	4010133052		
168		A	RESISTOR		R115	1-247-883-91	RES-CF 1/4W J 150K SMALL -AT-	4050515455		
169		A	RESISTOR		R116	1-247-851-91	RES-CF 1/4W J 6.8K SMALL -AT-	4050568255		
170		A	RESISTOR		R201	1-216-022-11	RES-CHIP 1/10W F 75R 0805	4010175002		
171		A	RESISTOR		R202	1-216-060-91	RES-CHIP 1/10W F 33R 0805	4010133002		
172		A	RESISTOR		R203	1-216-049-91	RES-CHIP 1/10W J 1K 0805	4010110252		
173		A	RESISTOR		R204	1-216-025-91	RES-CHIP 1/10W J 100R 0805	4010110152		
174		A	RESISTOR		R205	1-243-653-11	RES-CF 1/2WSS J 68R -AT-W=52mm	4050168055		
175		A	RESISTOR		R208	1-247-859-91	RES-CF 1/4W J 15K -AT- SMALL	4050515355		
176		A	RESISTOR		R211	1-216-121-91	RES-CHIP 1/10W J 1M 0805	4010110552		
177		A	RESISTOR		R212	1-202-549-00	RES-CC 1/2W K 100R -AT-	4060210115		
178		A	RESISTOR		R213	1-216-013-00	RES-CHIP 1/10W J 33R 0805	4010133052		
179		A	RESISTOR		R215	1-247-883-91	RES-CF 1/4W J 150K SMALL -AT-	4050515455		
180		A	RESISTOR		R216	1-247-851-91	RES-CF 1/4W J 6.8K SMALL -AT-	4050568255		
181		A	RESISTOR		R301	1-216-022-11	RES-CHIP 1/10W F 75R 0805	4010175002		
182		A	RESISTOR		R302	1-216-060-91	RES-CHIP 1/10W F 33R 0805	4010133002		
183		A	RESISTOR		R303	1-216-049-91	RES-CHIP 1/10W J 1K 0805	4010110252		
184		A	RESISTOR		R304	1-216-025-91	RES-CHIP 1/10W J 100R 0805	4010110152		
185		A	RESISTOR		R305	1-242-970-11	RES-CF 1/2WSS J 75R -AT-W=52mm	4050175055		
186		A	RESISTOR		R308	1-247-859-91	RES-CF 1/4W J 15K -AT- SMALL	4050515355		

No.	#	Board	Type	△/*	Ref.No.	Part No.	Description	Remarks-1	Remarks-2	Difference
187		A	RESISTOR		R311	1-216-121-91	RES-CHIP 1/10W J 1M 0805	4010110552		
188		A	RESISTOR		R312	1-202-549-00	RES-CC 1/2W K 100R -AT-	4060210115		
189		A	RESISTOR		R313	1-216-013-00	RES-CHIP 1/10W J 33R 0805	4010133052		
190		A	RESISTOR		R315	1-247-883-91	RES-CF 1/4W J 150K SMALL -AT-	4050515455		
191		A	RESISTOR		R316	1-247-851-91	RES-CF 1/4W J 6.8K SMALL -AT-	4050568255		
192		A	SPARK GAP		SG001	1-519-422-21	SPARK GAP 1.2KV AG-15 P:5mm-RT	5106122204		
193		A	SPARK GAP		SG101	1-519-504-32	SURGE PROTECTOR 200V 52M -AT-	4705415001		
194		A	SPARK GAP		SG201	1-519-504-32	SURGE PROTECTOR 200V 52M -AT-	4705415001		
195		A	SPARK GAP		SG301	1-519-504-32	SURGE PROTECTOR 200V 52M -AT-	4705415001		
196		A	TRANSISTOR		Q001	8-729-139-04	TRS. 2N3904 TO-92 -RT-	4111139040		
197		A	TRANSISTOR		Q002	8-729-139-04	TRS. 2N3904 TO-92 -RT-	4111139040		
198		A	TRANSISTOR		Q003	8-729-139-04	TRS.2N3904 TO-92 -RT-	4111139040		
199		A	TRANSISTOR		Q004	8-729-139-04	TRS. 2N3904 TO-92 -RT-	4111139040		
200		A	TRANSISTOR		Q005	8-729-206-21	TRS. RN1203 -RT-	4116612030		
201		A	TRANSISTOR		Q007	8-729-173-36	TRS. 2SA733-Q	4110007330		HMD-A200
202		D	CAPACITOR		C402	1-128-528-91	4CAP-EC3 470UFM 25V 10 X13-RT-	5153471T25		
203		D	CAPACITOR		C403	1-137-395-91	CAP-MC 0.022UFK 100V -RT-	5116223111		
204		D	CAPACITOR		C404	1-107-491-91	CAP-EC3 1000UFM 25V 10X20 -SF-	5153102S25		
205		D	CAPACITOR		C405	1-137-378-91	CAP-PETP FILM 0.22UFJ 50V P:5	5110224550		
206		D	CAPACITOR		C406	1-137-390-91	CAP-MC 0.0033UFK 100V -RT-	5116332111		
207		D	CAPACITOR		C407	1-137-395-91	CAP-MC 0.022UFJ 100V -RT-	5116223111		HMD-A200
208		D	CAPACITOR		C407	1-137-393-91	CAP-MC 0.01UFJ 100V -RT-	5116103511		HMD-A220
209		D	CAPACITOR		C408	1-126-951-11	CAP-EC6 470UFM 35V -RT-	5156471T35		
210		D	CAPACITOR		C409	1-108-365-51	CAP-MC 0.001UFK 100V -RT-	5116102111		
211		D	CAPACITOR		C500	1-137-391-91	CAP-MC 0.0047UFJ 100V -RT-	5116472511		
212		D	CAPACITOR		C501	1-135-913-11	CAP-MC 0.015UFJ 100V -RT-	5116153511		
213		D	CAPACITOR		C502	1-137-376-91	CAP-PETP FILM 0.1UFJ 50V P:5MM	5110104550		
214		D	CAPACITOR		C503	1-137-376-91	CAP-PETP FILM 0.1UFJ 50V P:5MM	5110104550		
215		D	CAPACITOR		C504	1-137-393-91	CAP-MC 0.01UFJ 100V -RT-	5116103511		
216		D	CAPACITOR		C505	1-135-383-11	CAP-MEF 0.1UFJ 100V CF	5075104501		
217		D	CAPACITOR		C506	1-137-393-91	CAP-MC 0.01UFJ 100V -RT-	5116103511		

No.	#	Board	Type	△/*	Ref.No.	Part No.	Description	Remarks-1	Remarks-2	Difference
218		D	CAPACITOR		C507	1-137-391-91	CAP-MC 0.0047UFJ 100V -RT-	5116472511		
219		D	CAPACITOR		C508	1-102-529-81	CAP-CCSL 100PFJ 50V -RT-	5128101552		
220		D	CAPACITOR		C509	1-137-390-91	CAP-MC 0.0033UFK 100V -RT-	5116332111		
221		D	CAPACITOR		C510	1-107-491-91	CAP-EC3 1000UFM 25V 10X20 -SF-	5153102S25		
222		D	CAPACITOR		C512	1-102-529-81	CAP-CCSL 100PFJ 50V -RT-	5128101552		
223		D	CAPACITOR		C513	1-102-529-81	CAP-CCSL 100PFJ 50V -RT-	5128101552		
224		D	CAPACITOR		C514	1-136-497-11	CAP-SCF 0.1UFZ 50V -RT-	5134104452		
225		D	CAPACITOR		C515	1-136-195-11	CAP-MEF 0.022UFK 250V P:10MM -	5074223102		
226		D	CAPACITOR		C517	1-128-981-11	CAP-CCR 220PFK 3KV P:7.5mm -SF	510H221193		
227		D	CAPACITOR		C518	1-135-409-11	CAP-CCR 1500PFK 1KV P:5mm -RT-	510H152132		
228		D	CAPACITOR		C521	1-135-807-11	CAP-PHA 5100PFH 1.8KV P:22.5M	5197512393		
229		D	CAPACITOR		C522	1-131-878-11	CAP-MPP 0.0033UFH 2KV P:15MM -	51903323A3		
230		D	CAPACITOR		C523	1-135-399-11	CAP-ECX 10UFM 160V -SF-	515X100S02		
231		D	CAPACITOR		C524	1-135-387-11	CAP-PMS 0.75UFJ 250V P:22.5MM	5198754583		
232		D	CAPACITOR		C525	1-115-511-11	CAP-PMS 0.12UFJ 250V -SF-	5198124583		
233		D	CAPACITOR		C526	1-135-917-11	CAP-PMS 0.22UFJ 250V -SF-	5198224583		
234		D	CAPACITOR		C527	1-115-511-11	CAP-PMS 0.12UFJ 250V -SF-	5198124583		
235		D	CAPACITOR		C529	1-137-391-91	CAP-MC 0.0047UFJ 100V -RT-	5116472511		
236		D	CAPACITOR		C530	1-136-497-11	CAP-SCF 0.1UFZ 50V -RT-	5134104452		
237		D	CAPACITOR		C531	1-137-395-91	CAP-MC 0.022UFK 100V -RT-	5116223111		
238		D	CAPACITOR		C532	1-108-365-51	CAP-MC 0.001UFK 100V -RT-	5116102111		
239		D	CAPACITOR		C533	1-136-173-91	CAP-MP 0.47UFJ 50V P:5.0MM	5074474505		
240		D	CAPACITOR		C535	1-108-365-51	CAP-MC 0.0022UFK 100V -RT-	5116222111		
241		D	CAPACITOR		C536	1-135-905-11	CAP-CCB 2700PFK 50V -RT-	5101272152		
242		D	CAPACITOR		C537	1-126-934-91	CAP-EC6 220UFM 16V -RT-	5156221T16		
243		D	CAPACITOR		C538	1-137-461-91	CAP-MC +-10% 0.012UF/100V -RT-	5116123111		
244		D	CAPACITOR		C539	1-137-395-91	CAP-MC 0.022UFK 100V -RT-	5116223111		
245		D	CAPACITOR		C540	1-135-914-11	CAP-MC 0.043UFK 100V	5116433111		
246		D	CAPACITOR		C541	1-126-934-91	CAP-EC6 220UFM 16V -RT-	5156221T16		
247		D	CAPACITOR		C542	1-137-395-91	CAP-MC 0.022UFK 100V -RT-	5116223111		
248		D	CAPACITOR		C545	1-136-497-11	CAP-SCF 0.1UFZ 50V -RT-	5134104452		

No.	#	Board	Type	△/*	Ref.No.	Part No.	Description	Remarks-1	Remarks-2	Difference
249		D	CAPACITOR		C546	1-136-497-11	CAP-SCF 0.1UFZ 50V -RT-	5134104452		
250		D	CAPACITOR		C547	1-137-376-91	CAP-PETP FILM 0.1UFJ 50V P:5MM	5110104550		
251		D	CAPACITOR		C548	1-135-403-11	CAP-EC6 220UFM 25V 8X12 -RT-	5156221T25		
252		D	CAPACITOR		C549	1-135-403-11	CAP-EC6 220UFM 25V 8X12 -RT-	5156221T25		
253		D	CAPACITOR		C550	1-135-352-11	CAP-MEF 0.01UFK 250V P10MM -SF	5074103102		
254		D	CAPACITOR		C553	1-126-933-91	CAP-EC6 100UFM 16V 6.3X11 -RT-	5156101T16		
255		D	CAPACITOR		C554	1-109-958-91	CAP-EC6 2.2UFM 160V 6.3X11 -RT	5156229T02		
256		D	CAPACITOR		C555	1-136-497-11	CAP-SCF 0.1UFZ 50V -RT-	5134104452		
257		D	CAPACITOR		C556	1-107-955-91	CAP-ECX 100UFM 200V 16 X25-SF-	515X101S07		
258		D	CAPACITOR		C557	1-135-383-11	CAP-MEF 0.1UFJ 100V CF	5075104501		
259		D	CAPACITOR		C560	1-137-391-91	CAP-MC 0.0047UFJ 100V -RT-	5116472511		
260		D	CAPACITOR		C570	1-117-216-11	CAP-CCR 2200PFK 2KV P:7.5mm -S	510H2221C3		
261		D	CAPACITOR		C573	1-136-190-91	CAP-MEF 0.15UFK 250V P:15mm -S	5074154102		
262		D	CAPACITOR		C574	1-126-964-91	CAP-EC6 10UFM 50V 5X11 -RT-	5156100T50		
263		D	CAPACITOR		C575	1-137-393-91	CAP-MC 0.01UFJ 100V -RT-	5116103511		
264		D	CAPACITOR		C576	1-136-497-11	CAP-SCF 0.1UFZ 50V -RT-	5134104452		
265		D	CAPACITOR		C577	1-135-394-11	CAP-EC6 4.7UFM 250V 8X12 -RT-	5156479T03		
266		D	CAPACITOR		C579	1-126-961-91	CAP-EC6 2.2UFM 50V 5X11 -RT-	5156229T50		
267		D	CAPACITOR		C580	1-135-898-11	CAP-ECB 47uFM 200V TM 13 X26	515B470S07		
268		D	CAPACITOR		C584	1-135-920-11	CAP-CCSL 15PFJ 2KV	51281505C2		
269		D	CAPACITOR		C585	1-164-143-11	CAP-CCB 1000PFK 1KV P:5MM -RT-	5101102132		
270		D	CAPACITOR		C586	1-135-357-11	CAP-CCSL 22PFJ 2KV P:5MM-RT-	51282205C2		
271		D	CAPACITOR		C587	1-135-388-11	CAP-PMV 0.22UFJ 250V P:15mm -S	5199224583		
272		D	CAPACITOR		C588	1-135-895-11	CAP-PMS 0.047UFJ 250V P:15MM	5198473583		
273		D	CAPACITOR		C589	1-135-398-11	CAP-EC6 1UFM 50V 6.3X11 -RT-	5156109T50		
274		D	CAPACITOR		C590	1-136-497-11	CAP-SCF 0.1UFZ 50V -RT-	5134104452		
275		D	CAPACITOR		C591	1-136-497-11	CAP-SCF 0.1UFZ 50V -RT-	5134104452		
276		D	CAPACITOR		C592	1-126-964-91	CAP-EC6 10UFM 50V 5X11 -RT-	5156100T50		
277		D	CAPACITOR		C593	1-137-378-91	CAP-PETP FILM 0.22UFJ 50V P:5	5110224550		
278		D	CAPACITOR		C594	1-117-216-11	CAP-CCR 2200PFK 2KV P:7.5mm -S	510H2221C3		
279		D	CAPACITOR		C595	1-136-199-11	CAP-MEF 0.1UFK 400V P:15MM -SF	5074104104		

No.	#	Board	Type	△/*	Ref.No.	Part No.	Descrption	Remarks-1	Remarks-2	Difference
280		D	CAPACITOR		C597	1-137-388-91	CAP-MC 0.0015UFK 100V -RT-	5116152111		
281		D	CAPACITOR		C598	1-135-806-11	CAP-MPP 0.47UFJ 100V -SF-	5190474503		
282		D	CAPACITOR		C599	1-126-969-11	CAP-EC6 220UFM 50V -RT-	5156221T50		
283		D	CAPACITOR		C5E4	1-126-964-91	CAP-EC6 10UFM 50V 5X11 -RT-	5156100T50		
284		D	CAPACITOR		C5E6	1-136-497-11	CAP-SCF 0.1UFZ 50V -RT-	5134104452		
285		D	CAPACITOR		C5E7	1-137-390-91	CAP-MC 0.0033UFK 100V -RT-	5116332111		
286		D	CAPACITOR		C5E8	1-137-378-91	CAP-PETP FILM 0.22UFJ 50V P:5	5110224550		
287		D	CAPACITOR		C5E9	1-137-378-91	CAP-PETP FILM 0.22UFJ 50V P:5	5110224550		
288		D	CAPACITOR		C5K1	1-135-398-11	CAP-EC6 1UFM 50V 6.3X11 -RT-	5156109T50		
289		D	CAPACITOR	△	C601	1-137-472-71	CAP-MPR 0.68UFM 250V P:27.5mm	5066684425		
290		D	CAPACITOR	△	C602	1-135-381-11	CAP-MPR 1UFM 250V -SF-	5066105425		
291		D	CAPACITOR		C603	1-135-380-11	CAP-CCS 470PFM AC 250V P:10mm	5063471325		
292		D	CAPACITOR		C604	1-135-380-11	CAP-CCS 470PFM AC 250V P:10mm	5063471325		
293		D	CAPACITOR		C605	1-135-351-11	CAP-CCS 4700PFM 250V P:10MM-SF	5063472425		
294		D	CAPACITOR		C606	1-135-396-11	CAP-ECP 330UFM 400V -SF- W/O	515P331S04		U/C
295		D	CAPACITOR		C606	1-135-831-11	CAP-ECP 330UFM 450V -SF- W/O	515P331P45		AEP
296		D	CAPACITOR		C607	1-126-947-91	CAP-EC6 47UFM 35V 6.3X11 -RT-	5156470T35		
297		D	CAPACITOR		C608	1-136-199-11	CAP-MEF 0.1UFK 400V P:15MM -SF	5074104104		
298		D	CAPACITOR		C610	1-135-351-11	CAP-CCS 4700PFM 250V P:10MM-SF	5063472425		
299		D	CAPACITOR		C611	1-102-112-91	CAP-CCSL 330PFJ 50V -RT-	5128331552		
300		D	CAPACITOR		C612	1-135-916-11	METALIZED PP 0.01MF	5092103615		
301		D	CAPACITOR		C613	1-135-386-11	CAP-CCSL 270PFJ 50V -RT-	5128271552		
302		D	CAPACITOR		C614	1-136-497-11	CAP-SCF 0.1UFZ 50V -RT-	5134104452		
303		D	CAPACITOR		C615	1-126-933-91	CAP-EC6 100UFM 16V 6.3X11 -RT-	5156101T16		
304		D	CAPACITOR		C616	1-136-497-11	CAP-SCF 0.1UFZ 50V -RT-	5134104452		
305		D	CAPACITOR		C618	1-126-964-91	CAP-EC6 10UFM 50V 5X11 -RT-	5156100T50		
306		D	CAPACITOR		C619	1-136-497-11	CAP-SCF 0.1UFZ 50V -RT-	5134104452		
307		D	CAPACITOR		C620	1-135-901-11	CAP-CCR 330PFK 1KV P:5mm -RT-	510H331132		
308		D	CAPACITOR		C622	1-135-804-11	CAP-MEF 0.47UFK 63V -RT-	5075474163		
309		D	CAPACITOR		C623	1-136-497-11	CAP-SCF 0.1UFZ 50V -RT-	5134104452		HMD-220
310		D	CAPACITOR		C624	1-108-365-51	CAP-MC 0.001UFK 100V -RT-	5116102111		

No.	#	Board	Type	△/*	Ref.No.	Part No.	Description	Remarks-1	Remarks-2	Difference
311		D	CAPACITOR		C625	1-111-173-11	CAP-EC6 220UFM 100V -SF-	5156221S01		
312		D	CAPACITOR		C626	1-107-955-91	CAP-ECX 100UFM 200V 16 X25-SF-	515X101S07		
313		D	CAPACITOR		C628	1-107-491-91	CAP-EC3 1000UFM 25V 10X20 -SF-	5153102S25		
314		D	CAPACITOR		C630	1-128-528-91	4CAP-EC3 470UFM 25V 10 X13-RT-	5153471T25		
315		D	CAPACITOR		C632	1-107-491-91	CAP-EC3 1000UFM 25V 10X20 -SF-	5153102S25		
316		D	CAPACITOR		C633	1-107-491-91	CAP-EC3 1000UFM 25V 10X20 -SF-	5153102S25		
317		D	CAPACITOR		C636	1-164-143-11	CAP-CCB 1000PFK 1KV P:5MM -RT-	5101102132		
318		D	CAPACITOR		C642	1-126-935-91	CAP-EC6 470UFM 16V 8X12 -RT-	5156471T16		
319		D	CAPACITOR		C645	1-126-935-91	CAP-EC6 470UFM 16V 8X12 -RT-	5156471T16		
320		D	CAPACITOR		C646	1-137-392-91	CAP-MC 6800PFK 100V -RT-	5116682111		
321		D	CAPACITOR		C647	1-135-401-11	CAP-EC6 100UFM 35V 8X12 -RT-	5156101T35		
322		D	CAPACITOR		C648	1-135-351-11	CAP-CCS 4700PFM 250V P:10MM-SF	5063472425		
323		D	CAPACITOR		C649	1-135-351-11	CAP-CCS 4700PFM 250V P:10MM-SF	5063472425		
324		D	CAPACITOR		C650	1-136-497-11	CAP-SCF 0.1UFZ 50V -RT-	5134104452		
325		D	CAPACITOR		C651	1-107-491-91	CAP-EC3 1000UFM 25V 10X20 -SF-	5153102S25		
326		D	CAPACITOR		C652	1-164-143-11	CAP-CCB 1000PFK 1KV P:5MM -RT-	5101102132		
327		D	CAPACITOR		C655	1-135-911-11	CAP-MEF 0.47UFJ 100V -SF-	5074474501		
328		D	CAPACITOR		C657	1-135-383-11	CAP-MEF 0.1UFJ 100V CF	5075104501		
329		D	CAPACITOR		C658	1-137-393-91	CAP-MC 0.01UFJ 100V -RT-	5116103511		
330		D	CAPACITOR		C659	1-135-392-11	CAP-ECN 470UFM 25V WG 10X20mm	515N471S25		
331		D	CAPACITOR		C701	1-135-360-11	CAP-COG 1000PFJ 50V -AT-	7181102552		
332		D	CAPACITOR		C702	1-135-360-11	CAP-COG 1000PFJ 50V -AT-	7181102552		
333		D	CAPACITOR		C7A2	1-135-918-11	CAP-EC2 220UFM 10V -RT-	5152221T10		
334		D	CAPACITOR		C7B1	1-135-355-11	CAP-CCCH 22PFJ 50V -RT-	5121220552		
335		D	CAPACITOR		C7B2	1-135-355-11	CAP-CCCH 22PFJ 50V -RT-	5121220552		
336		D	CAPACITOR		C7B3	1-115-873-91	CAP-EC2 3.3UFM 50V -RT-	5152339T50		
337		D	CAPACITOR		C7C1	1-136-497-11	CAP-SCF 0.1UFZ 50V -RT-	5134104452		
338		D	CAPACITOR		C7C2	1-136-497-11	CAP-SCF 0.1UFZ 50V -RT-	5134104452		
339		D	CAPACITOR		C7C3	1-136-497-11	CAP-SCF 0.1UFZ 50V -RT-	5134104452		
340		D	CAPACITOR		C7C4	1-136-497-11	CAP-SCF 0.1UFZ 50V -RT-	5134104452		
341		D	CAPACITOR		C7C5	1-135-918-11	CAP-EC2 220UFM 10V -RT-	5152221T10		



No.	#	Board	Type	△/*	Ref.No.	Part No.	Description	Remarks-1	Remarks-2	Difference
342		D	CAPACITOR		C7C6	Pending	CAP-CCB 0.1UFK 50V -RT-	5101104152		
343		D	CAPACITOR		C7E1	1-136-497-11	CAP-SCF 0.1UFZ 50V -RT-	5134104452		
344		D	CAPACITOR		C900	1-136-497-11	CAP-SCF 0.1UFZ 50V -RT-	5134104452		
345		D	CAPACITOR		C901	1-135-395-11	CAP-EC6 4.7UFM 50V 5X11 -RT-	5156479T50		
346		D	CAPACITOR		C902	1-104-660-91	CAP-EC6 47UFM 16V 5X11 -RT-	5156470T16		
347		D	CAPACITOR		C903	1-126-961-91	CAP-EC6 2.2UFM 50V 5X11 -RT-	5156229T50		
348		D	CAPACITOR		C904	1-126-961-91	CAP-EC6 2.2UFM 50V 5X11 -RT-	5156229T50		
349		D	CAPACITOR		C905	1-126-961-91	CAP-EC6 2.2UFM 50V 5X11 -RT-	5156229T50		
350		D	CAPACITOR		C906	1-126-961-91	CAP-EC6 2.2UFM 50V 5X11 -RT-	5156229T50		
351		D	CAPACITOR		C907	1-126-964-91	CAP-EC6 10UFM 50V 5X11 -RT-	5156100T50		
352		D	CAPACITOR		C908	1-136-497-11	CAP-SCF 0.1UFZ 50V -RT-	5134104452		
353		D	CAPACITOR		C910	1-126-964-91	CAP-EC6 10UFM 50V 5X11 -RT-	5156100T50		
354		D	CAPACITOR		C912	1-102-529-81	CAP-CCSL 100PFJ 50V -RT-	5128101552		
355		D	CAPACITOR		C913	1-102-529-81	CAP-CCSL 100PFJ 50V -RT-	5128101552		
356		D	CAPACITOR		C914	1-126-964-91	CAP-EC6 10UFM 50V 5X11 -RT-	5156100T50		
357		D	CAPACITOR		C915	1-135-355-11	CAP-CCCH 22PFJ 50V -RT-	5121220552		
358		D	CAPACITOR		C916	1-135-355-11	CAP-CCCH 22PFJ 50V -RT-	5121220552		
359		D	CAPACITOR		C917	1-102-074-11	CAP-EC6 0.001MF 50V 5X11 -RT-	5101102152		HMD-A200
360		D	CAPACITOR		C917	1-126-961-91	CAP-EC6 2.2UFM 50V 5X11 -RT-	5156229T50		HMD-A220
361		D	CAPACITOR		C923	1-126-961-91	CAP-EC6 2.2UFM 50V 5X11 -RT-	5156229T50		
362		D	CAPACITOR		C924	1-126-961-91	CAP-EC6 2.2UFM 50V 5X11 -RT-	5156229T50		
363		D	CAPACITOR		C930	1-136-497-11	CAP-SCF 0.1UFZ 50V -RT-	5134104452		
364		D	COIL		L502	1-419-444-11	COIL PEAKING 100UH -AT-	432A101006		
365		D	COIL		L503	1-459-104-21	COIL CHOKE 10mH W/BASE (DR 12X	4323103003		
366		D	COIL		L505	1-419-464-11	COIL LINEARITY	708S207R50		
367		D	COIL		L506	1-459-104-21	COIL CHOKE 10mH W/BASE (DR 12X	4323103003		
368		D	COIL		L507	1-412-550-25	INDUCTOR MICRO 1.2MMH	4323122003		
369		D	COIL		L508	1-410-328-11	COIL PEAKING 10UH -AT-	4321100006		
370		D	COIL		L570	1-416-989-11	CHOKE COIL 7UH	4323709003		
371		D	COIL		L5K1	1-419-615-11	COIL PEAKING 150UH SS -TYPE	432B151006		
372		D	COIL		L601	1-412-537-25	COIL CHOKE 100uH	4323101303		

No.	#	Board	Type	△/*	Ref.No.	Part No.	Description	Remarks-1	Remarks-2	Difference
373		D	COIL		L602	1-412-537-25	COIL CHOKE 100uH	4323101303		
374		D	COIL		L603	1-412-537-25	COIL CHOKE 100uH	4323101303		
375		D	COIL		L604	1-412-537-25	COIL CHOKE 100uH	4323101303		
376		D	COIL		L607	1-410-645-41	MICRO INDUCTOR 100UH +-5%	4326101005		
377		D	COIL		L610	1-419-447-11	TOROID CHOKE COIL W/TUBE 130UH	7067A10131		
378		D	COIL		L611	1-410-645-41	MICRO INDUCTOR 100UH +-5%	4326101005		
379		D	COIL		L7A8	1-469-807-11	INDUCTOR (SMALL TYPE)	4322502006		
380		D	COIL		L7C1	1-412-911-11	FERRITE BEAD 2.3UH	7099159250		
381		D	COIL		L7C2	1-469-807-11	INDUCTOR (SMALL TYPE)	4322502006		
382		D	COIL		L7C3	1-469-807-11	INDUCTOR (SMALL TYPE)	4322502006		
383		D	COIL		L7C4	1-419-626-11	CORE-FE (R6H 6X10X0.8) 3T	5560070017		
384		D	COIL		L7C5	1-469-807-11	INDUCTOR (SMALL TYPE)	4322502006		
385		D	COIL		L7C6	1-469-807-11	INDUCTOR (SMALL TYPE)	4322502006		
386		D	COIL		L7C7	1-469-807-11	INDUCTOR (SMALL TYPE)	4322502006		
387		D	COIL		L7C8	1-469-807-11	INDUCTOR (SMALL TYPE)	4322502006		
388		D	COIL		L7C9	1-469-807-11	INDUCTOR (SMALL TYPE)	4322502006		
389		D	COIL		L7D1	1-469-807-11	INDUCTOR (SMALL TYPE)	4322502006		
390		D	CONNECTOR	*	CN501	1-580-798-11	DY WIRE	C488040030		
391		D	CONNECTOR	*	CN504	1-564-513-11	CONN. 10P 2.5mm W232V10T00	4491000330		
392		D	CONNECTOR	*	CN506	1-695-915-11	CONTACT T=0.5 W=4.75MM	4490100209		
393		D	CONNECTOR	*	CN507	1-695-915-11	CONTACT T=0.5 W=4.75MM	4490100209		
394		D	CONNECTOR	△	CN601	1-251-444-11	AC SOCKET	4570704350		
395		D	CONNECTOR	*	CN602	1-793-920-11	CONN. 3.96 3P W/O PIN 2 -SF-	4490300190		
396		D	CONNECTOR	*	CN603	1-691-960-11	CONN. 3P LPC BOAR 2'ND OPEN BX	4490301100		
397		D	CONNECTOR	*	CN605	1-695-915-11	CONTACT T=0.5 W=4.75MM	4490100209		
398		D	CONNECTOR	*	CN901	1-564-514-11	CONN. 11P 2.5mm W232V11T00	4491100330		
399		D	CONNECTOR	*	CN902	1-564-511-11	CONN. 8P 2.5mm W232V08T00	4490800330		
400		D	CONNECTOR	*	CN906	1-564-510-11	CONN.7P 2.0MM B7B-PH-K	4490700200		
401		D	CRYSTAL		X7A1	1-781-720-11	""""VIBRATOR, CRYSTAL""""	7156000014		
402		D	CRYSTAL		X901	1-781-719-11	CRYSTAL 24MHz AT-49 +-30ppm	7152400010		
403		D	DIODE		D402	8-719-904-02	DIODE 1N4002 -AT-	4120104002		

No.	#	Board	Type	△/*	Ref.No.	Part No.	Description	Remarks-1	Remarks-2	Difference
404		D	DIODE		D501	8-719-921-20	DIODE 1SS119TD -AT-	4120511900		
405		D	DIODE		D502	8-719-923-03	Z-D MTZJ15A (13.44-14.13V)	41205015AU		
406		D	DIODE		D503	8-719-079-06	DIODE ER304 DO-201AD 400V/3A	4130303040		
407		D	DIODE		D504	8-719-921-20	DIODE 1SS119TD -AT-	4120511900		
408		D	DIODE		D506	8-719-921-20	DIODE 1SS119TD -AT-	4120511900		
409		D	DIODE		D507	9-990-930-01	DIODE EGP10B	413010110B		
410		D	DIODE		D508	8-719-075-31	DIODE DD54RC TO-220ML 1500V/5A	4130500540		
411		D	DIODE		D509	8-719-921-22	DIODE ZENER MTZJ9.1C -AT-	41205091CU		
412		D	DIODE		D510	8-719-923-33	Z-D MTZJ5.1A (4.81-5.07V)	41205051AU		
413		D	DIODE		D511	8-719-074-17	DIODE PS104R 400V/1A DO-41 -A	4130101040		
414		D	DIODE		D512	8-719-074-17	DIODE PS104R 400V/1A DO-41 -A	4130101040		
415		D	DIODE		D513	8-719-074-13	DIODE BYV26C 1A/600V -AT-	413010426C		
416		D	DIODE		D514	8-719-074-25	DIODE PG104R 1A/400V -AT-	4130101041		
417		D	DIODE		D515	8-719-921-20	DIODE 1SS119TD -AT-	4120511900		
418		D	DIODE		D516	8-719-921-20	DIODE 1SS119TD -AT-	4120511900		
419		D	DIODE		D517	8-719-921-20	DIODE 1SS119TD -AT-	4120511900		
420		D	DIODE		D518	8-719-921-20	DIODE 1SS119TD -AT-	4120511900		
421		D	DIODE		D519	8-719-074-17	DIODE PS104R 400V/1A DO-41 -A	4130101040		
422		D	DIODE		D521	8-719-074-17	DIODE PS104R 400V/1A DO-41 -A	4130101040		
423		D	DIODE		D522	8-719-074-25	DIODE PG104R 1A/400V -AT-	4130101041		
424		D	DIODE		D523	8-719-921-20	DIODE 1SS119TD -AT-	4120511900		
425		D	DIODE		D526	8-719-074-17	DIODE PS104R 400V/1A DO-41 -A	4130101040		
426		D	DIODE		D527	8-719-921-20	DIODE 1SS119TD -AT-	4120511900		
427		D	DIODE		D528	8-719-079-06	DIODE ER304 DO-201AD 400V/3A	4130303040		
428		D	DIODE		D529	8-719-074-25	DIODE PG104R 1A/400V -AT-	4130101041		
429		D	DIODE		D531	8-719-077-90	DIODE RGP10M -AT-	413010010M		
430		D	DIODE		D532	8-719-923-03	DIODE ZENER MTZJ15A	41205015AU		
431		D	DIODE		D592	8-719-921-20	DIODE 1SS119TD -AT-	4120511900		
432		D	DIODE		D5K1	8-719-941-51	DIODE ZENER HZ5B1 -AT-	41205005B1		
433		D	DIODE	△	D601	8-719-025-88	DIODE BRIDGE GBU4J(B4) P:7.5mm	4130400083		HMD-A220
434		D	DIODE		D602	8-719-921-20	DIODE 1SS119TD -AT-	4120511900		

No.	#	Board	Type	△/*	Ref.No.	Part No.	Description	Remarks-1	Remarks-2	Difference
435		D	DIODE		D604	8-719-074-17	DIODE PS104R 400V/1A DO-41 -A	4130101040		
436		D	DIODE		D605	8-719-074-13	DIODE BYV26C 1A/600V -AT-	413010426C		
437		D	DIODE		D606	8-719-921-20	DIODE 1SS119TD -AT-	4120511900		
438		D	DIODE		D607	8-719-902-82	DIODE ZENER HZ18-2 V -AT-	4120501802		
439		D	DIODE		D608	8-719-922-32	DIODE ZENER HZ22-2	4120502202		
440		D	DIODE		D609	8-719-921-20	DIODE 1SS119TD -AT-	4120511900		
441		D	DIODE		D610	8-719-921-20	DIODE 1SS119TD -AT-	4120511900		
442		D	DIODE		D611	8-719-921-20	DIODE 1SS119TD -AT-	4120511900		
443		D	DIODE		D613	8-719-054-72	DIODE 31DF6 -AT-	41303031F6		
444		D	DIODE		D615	8-719-054-72	DIODE 31DF6 -AT-	41303031F6		
445		D	DIODE		D616	8-719-074-19	DIODE UF5402G -AT-	4130305402		
446		D	DIODE		D617	8-719-074-19	DIODE UF5402G -AT-	4130305402		
447		D	DIODE		D618	8-719-074-19	DIODE UF5402G -AT-	4130305402		
448		D	DIODE		D619	8-719-921-20	DIODE 1SS119TD -AT-	4120511900		
449		D	DIODE		D621	8-719-921-20	DIODE 1SS119TD -AT-	4120511900		
450		D	DIODE		D622	8-719-085-00	DIODE 3A/200V 31DF2	41303031F2		
451		D	DIODE		D626	8-719-921-20	DIODE 1SS119TD -AT-	4120511900		
452		D	DIODE		D627	8-719-975-76	DIODE SB140 1A/40V -AT-	4130104140		
453		D	DIODE		D629	8-719-921-20	DIODE 1SS119TD -AT-	4120511900		
454		D	DIODE		D630	8-719-921-20	DIODE 1SS119TD -AT-	4120511900		
455		D	DIODE		D631	8-719-984-46	DIODE SB360 DO-201AD 60V/3A	4130300360		
456		D	DIODE		D632	8-719-921-20	DIODE 1SS119TD -AT-	4120511900		
457		D	DIODE		D633	8-719-921-20	DIODE 1SS119TD -AT-	4120511900		
458		D	DIODE		D634	8-719-921-20	DIODE 1SS119TD -AT-	4120511900		
459		D	DIODE		D635	8-719-902-82	DIODE ZENER HZ18-2 V -AT-	4120501802		
460		D	DIODE		D636	8-719-943-63	DIODE ZENER 6.2V HZ6C-3 -AT-	41205006C3		
461		D	DIODE		D637	8-719-904-01	DIODE 1N4002 -AT-	4120104002		
462		D	DIODE		D638	8-719-077-81	Z-D 1W 160V +-5% DO-41 -AT-	4120510160		
463		D	DIODE		D7A1	8-719-923-33	Z-D MTZJ5.1A (4.81-5.07V)	41205051AU		
464		D	DIODE		D903	8-719-921-20	DIODE 1SS119TD -AT-	4120511900		
465		D	DIODE		D905	8-719-923-33	Z-D MTZJ5.1A (4.81-5.07V)	41205051AU		

No.	#	Board	Type	△/*	Ref.No.	Part No.	Description	Remarks-1	Remarks-2	Difference
466		D	DIODE		D906	8-719-923-33	Z-D MTZJ5.1A (4.81-5.07V)	41205051AU		
467		D	DIODE		D907	8-719-923-33	Z-D MTZJ5.1A (4.81-5.07V)	41205051AU		
468		D	DIODE		D908	8-719-923-33	Z-D MTZJ5.1A (4.81-5.07V)	41205051AU		
469		D	DIODE		D909	8-719-923-33	Z-D MTZJ5.1A (4.81-5.07V)	41205051AU		
470		D	DIODE		D910	8-719-921-20	DIODE 1SS119TD -AT-	4120511900		
471		D	DIODE		D911	8-719-921-20	DIODE 1SS119TD -AT-	4120511900		
472		D	DIODE		ZD501	8-719-077-81	Z-D 1M160Z 1W 160V +-5% DO-41	4120510160		
473		D	FERRITE BEAD		FB501	1-469-402-11	FERRITE BEAD 3UH -AT-	4322309006		
474		D	FERRITE BEAD		FB502	1-469-611-11	FERRITE BEAD 2UH	4322209005		
475		D	FERRITE BEAD		FB503	1-469-611-11	FERRITE BEAD 2UH	4322209005		
476		D	FERRITE BEAD		FB504	1-469-402-11	FERRITE BEAD 3UH -AT-	4322309006		
477		D	FERRITE BEAD		FB601	1-469-402-11	FERRITE BEAD 3UH -AT-	4322309006		
478		D	FERRITE BEAD		FB602	1-469-401-11	FERRITE BEAD 3UH	4322309504		
479		D	FERRITE BEAD		FB603	1-412-911-11	FERRITE BEAD 2.3UH	7099159250		
480		D	FERRITE BEAD		FB605	1-469-402-11	FERRITE BEAD 3UH -AT-	4322309006		
481		D	FERRITE BEAD		FB606	1-469-402-11	FERRITE BEAD 3UH -AT-	4322309006		
482		D	FERRITE BEAD		FB607	1-469-401-11	FERRITE BEAD 3UH	4322309504		
483		D	FERRITE BEAD		FB608	1-469-401-11	FERRITE BEAD 3UH	4322309504		
484		D	FERRITE BEAD		FB609	1-469-401-11	FERRITE BEAD 3UH	4322309504		
485		D	FERRITE BEAD		FB610	1-469-401-11	FERRITE BEAD 3UH	4322309504		
486		D	FERRITE BEAD		FB612	1-419-445-11	TOROID CHOKE 300UH	7065R10301		
487		D	FERRITE BEAD		FB614	1-419-445-11	TOROID CHOKE 300UH	7065R10301		
488		D	FERRITE BEAD		FB616	1-419-626-11	CORE-FE (R6H 6X10X0.8) 3T	5560070017		
489		D	FERRITE BEAD		FB617	1-419-626-11	CORE-FE (R6H 6X10X0.8) 3T	5560070017		
490		D	FERRITE BEAD		FB620	1-469-401-11	FERRITE BEAD 3UH	4322309504		
491		D	FERRITE BEAD		FB621	1-469-401-11	FERRITE BEAD 3UH	4322309504		
492		D	FERRITE BEAD		FB622	1-469-401-11	FERRITE BEAD 3UH	4322309504		
493		D	FERRITE BEAD		FB623	1-469-402-11	FERRITE BEAD 3UH -AT-	4322309006		
494		D	FERRITE BEAD		FB624	1-469-401-11	FERRITE BEAD 3UH	4322309504		
495		D	FERRITE BEAD		FB901	1-469-403-11	FERRITE BEAD 2UH -AT-	4322209046		
496		D	FERRITE BEAD		L7D3	1-412-911-11	FERRITE BEAD 2.3UH	7099159250		

No.	#	Board	Type	△/*	Ref.No.	Part No.	Description	Remarks-1	Remarks-2	Difference
497		D	FERRITE BEAD		L7D4	1-469-402-11	FERRITE BEAD 3UH -AT-	4322309006		
498		D	FERRITE BEAD		L7D5	1-412-911-11	FERRITE BEAD 2.3UH	7099159250		
499		D	FERRITE BEAD		L7D7	1-414-793-21	FERRITE BEAD 0.45uH	7099458250		
500		D	FERRITE BEAD		L7D8	1-414-793-21	FERRITE BEAD 0.45uH	7099458250		
501		D	FERRITE BEAD		L7E3	1-412-911-11	FERRITE BEAD 2.3UH	7099159250		
502		D	FERRITE BEAD		L7E4	1-412-911-11	FERRITE BEAD 2.3UH	7099159250		
503		D	FILTER	△	LF601	1-433-798-11	COMMON MODE CHOKE	7065Y11133		
504		D	FUSE	△	F601	1-576-231-11	FUSE 4A/250VAC 5X20 SLO-BLO	5268400052		
505		D	IC		IC401	8-759-593-28	IC LA78040	4159780400		
506		D	IC		IC501	8-759-582-05	IC TDA4856/V2 32PIN SOT232-1	4159485600		
507		D	IC		IC502	8-759-450-95	IC LM 393 8PIN	4159393000		
508		D	IC		IC503	8-759-991-16	IC LM358 8PIN	4159358000		
509		D	IC		IC504	8-759-991-16	IC LM358 8PIN	4159358000		
510		D	IC		IC601	8-759-582-09	IC UC3842A 8PIN	4159384200		
511		D	IC		IC602	8-749-010-59	POTO COUPLER 4P TLP721F (GR)	4159072100		
512		D	IC		IC603	8-759-007-23	IC TL431 REGULATOR TO-92 -RT-	415943100A		
513		D	IC		IC606	8-729-048-22	TRS. MCR100-6 TO-92 -RT-	4114501006		
514		D	IC		IC607	8-759-279-76	IC MCT7812CT TO-220AB	4159781201		
515		D	IC		IC608	8-729-051-32	TRS. SCR MCR100-8 TO-92 -RT-	4114510080		
516		D	IC		IC609	8-749-017-26	IC SI8050S	41598050S0		
517		D	IC		IC7A1	8-759-654-37	IC ISP1122ANB 32PIN	4159112210		
518	#16	D	IC		IC7A3	6-700-978-01	IC MIC2026-2BN DIP-8PIN	4159202602		
519	#16	D	IC		IC7A4	6-700-978-01	IC MIC2026-2BN DIP-8PIN	4159202602		
520		D	IC		IC901	8-759-684-95	IC ST72751N9B1/LJP 56PIN	4159727516		
521		D	IC		IC902	8-759-650-44	IC M24C16BN-6 8PIN DIP	415924C160		
522		D	IC		IC903	8-759-605-05	IC M51951BSL	4159519510		
523		D	NETWORK RESISTOR		RN8A1	1-234-471-11	RES-NET 7P J 15K COMMON	4082071535		
524		D	NETWORK RESISTOR		RN8A2	1-234-472-11	RES-NET 8P J 15K COMMON	4082081535		
525		D	NETWORK RESISTOR		RN901	1-234-276-11	RES-NET 8P J 3.3K COMMON	4082083325		
526		D	NETWORK RESISTOR		RN902	1-234-277-11	RES-NET 8P J 4.7K COMMON	4082084725		
527		D	RELAY	△	RY601	1-755-031-11	RELAY OSA-SS-212DM5	4420612014		

No.	#	Board	Type	△/*	Ref.No.	Part No.	Description	Remarks-1	Remarks-2	Difference
528		D	RESISTOR		R401	1-242-983-11	RES-PR MF 1/4W F 2K AT SMALL	4257042001		
529		D	RESISTOR		R402	1-243-650-11	RES-PR MF 1/4W F 2.1K SMALL -A	4257042101		
530		D	RESISTOR		R403	1-243-471-11	RES-CF 1/2WSS J 3.3R NON-FLAME	4050133953		
531		D	RESISTOR		R404	1-216-348-91	RES-MOF 1W J 0.82R -SF-	4171082853		
532		D	RESISTOR		R405	Pending	RES-PR MF 1/4W F 590R -AT-	4257045900		
533		D	RESISTOR		R406	1-243-656-11	RES-CF 1/4W J 2.4R SMALL -AT-	4050524955		
534		D	RESISTOR		R407	1-242-977-11	RES-MOF 1W J 200R SMALL-IT-	4177120156		
535		D	RESISTOR		R409	1-240-899-11	RES-PR MF 1/4W F5.49 K SMALL	4257045491		
536		D	RESISTOR		R410	1-247-842-91	RES-CF 1/4W J 3.0K -AT- SMALL	4050530255		HMD-A200
537		D	RESISTOR		R410	1-247-839-91	RES-CF 1/4W J 2.2K -AT- SMALL	4050522255		HMD-A220
538		D	RESISTOR		R411	1-242-988-11	RES-PR MF 1/4W F 6.81K SMALL -	4257046811		
539		D	RESISTOR		R412	1-242-988-11	RES-PR MF 1/4W F 6.81K SMALL -	4257046811		
540		D	RESISTOR		R413	1-247-831-91	RES-CF 1/4W J 1K -AT- SMALL	4050510255		
541		D	RESISTOR		R500	1-247-783-91	RES-CF 1/4W J 10R -AT- SMALL	4050510055		
542		D	RESISTOR		R501	1-242-999-11	RES-CF 1/4W J 27K NON-FLAME -S	4050527353		
543		D	RESISTOR		R502	1-240-905-11	RES-PR MF 1/4W F 22.1K SMALL -	4257042212		
544		D	RESISTOR		R503	1-247-847-91	RES-CF 1/4W J 4.7K -AT- SMALL	4050547255		
545		D	RESISTOR		R504	1-240-891-11	RES-PR MF 1/4W F 1.18K SMALL -	4257041181		
546		D	RESISTOR		R505	1-240-894-11	RES-PR MF 1/4W F 2.8K AT SMALL	4257042801		
547		D	RESISTOR		R506	1-247-855-91	RES-CF 1/4W J 10K -AT- SMALL	4050510355		
548		D	RESISTOR		R508	1-240-904-11	RES-PR MF 1/4W F 18.2K SMALL -	4257041822		
549		D	RESISTOR		R510	1-247-807-91	RES-CF 1/4W J 100R -AT- SMALL	4050510155		
550		D	RESISTOR		R511	1-247-807-91	RES-CF 1/4W J 100R -AT- SMALL	4050510155		
551		D	RESISTOR		R512	1-242-969-11	RES-CF 1/2WSS J 4.3K NON-FLAME	4050143253		
552		D	RESISTOR		R513	1-247-807-91	RES-CF 1/4W J 100R -AT- SMALL	4050510155		
553		D	RESISTOR		R515	1-247-831-91	RES-CF 1/4W J 1K -AT- SMALL	4050510255		
554		D	RESISTOR		R516	1-247-831-91	RES-CF 1/4W J 1K -AT- SMALL	4050510255		
555		D	RESISTOR		R517	1-247-824-91	RES-CF 1/4W J 510R SMALL -AT-	4050551155		
556		D	RESISTOR		R518	1-247-896-91	RES-CF 1/4W J 510K SMALL -AT-	4050551455		
557		D	RESISTOR		R519	1-243-651-11	RES-PR MF 1/4W F 3.24K SMALL -	4257043241		
558		D	RESISTOR		R520	1-243-483-11	RES-CF 1/4W J 7.5K -AT- SMALL	4050575255		

No.	#	Board	Type	△/*	Ref.No.	Part No.	Description	Remarks-1	Remarks-2	Difference
559		D	RESISTOR		R521	1-240-900-11	RES-PR MF 1/4W F 7.5K AT SMALL	4257047501		
560		D	RESISTOR		R522	1-247-847-91	RES-CF 1/4W J 4.7K -AT- SMALL	4050547255		
561		D	RESISTOR		R524	1-247-853-91	RES-CF 1/4W J 8.2K -AT- SMALL	4050582255		
562		D	RESISTOR		R525	1-243-654-11	RES-CF 1/4W J 130R SMALL -AT-	4050513155		
563		D	RESISTOR		R526	1-247-847-91	RES-CF 1/4W J 4.7K -AT- SMALL	4050547255		
564		D	RESISTOR		R527	1-247-855-91	RES-CF 1/4W J 10K -AT- SMALL	4050510355		
565		D	RESISTOR		R529	1-247-823-91	RES-CF 1/4W J 470R SMALL -AT-	4050547155		
566		D	RESISTOR		R530	1-216-375-81	RES-MOF 2W J 3.3R -SF-	4172033953		
567		D	RESISTOR		R531	1-247-855-91	RES-CF 1/4W J 10K -AT- SMALL	4050510355		
568		D	RESISTOR		R532	1-242-980-11	RES-MOF 1W J 47R SMALL -AT-	4177147056		
569		D	RESISTOR		R533	1-243-675-11	RES-MOF 1W J 1.3K -SF-	4171013253		
570		D	RESISTOR		R534	1-216-857-81	RES-MOF 2W J 10R -SF-	4172010053		
571		D	RESISTOR		R535	1-242-997-11	RES-CF 1/4W J 1K SMALL NON-FLA	4050610252		
572		D	RESISTOR		R536	1-247-851-91	RES-CF 1/4W J 6.8K SMALL -AT-	4050568255		
573		D	RESISTOR		R538	1-247-847-91	RES-CF 1/4W J 4.7K -AT- SMALL	4050547255		
574		D	RESISTOR		R539	1-247-855-91	RES-CF 1/4W J 10K -AT- SMALL	4050510355		
575		D	RESISTOR		R540	1-260-135-91	RES-CF 1/2WSS J 1M-AT-W=52mm	4050110555		
576		D	RESISTOR		R543	1-242-979-11	RES-MOF 1W J 270R -IB-	4171027155		
577		D	RESISTOR		R544	1-260-123-11	RES-CF 1/2WSS J 100K -AT- W=52	4050110455		
578		D	RESISTOR		R545	1-260-123-11	RES-CF 1/2WSS J 100K -AT- W=52	4050110455		
579		D	RESISTOR		R546	1-260-123-11	RES-CF 1/2WSS J 100K -AT- W=52	4050110455		
580		D	RESISTOR		R547	1-247-847-91	RES-CF 1/4W J 4.7K -AT- SMALL	4050547255		
581		D	RESISTOR		R548	1-247-847-91	RES-CF 1/4W J 4.7K -AT- SMALL	4050547255		
582		D	RESISTOR		R549	1-247-855-91	RES-CF 1/4W J 10K -AT- SMALL	4050510355		
583		D	RESISTOR		R550	1-247-855-91	RES-CF 1/4W J 10K -AT- SMALL	4050510355		
584		D	RESISTOR		R551	1-247-871-91	RES-CF 1/4W J 47K -AT- SMALL	4050547355		
585		D	RESISTOR		R552	1-240-889-11	RES-PR MF 1/4W F 100R AT SMALL	4257041000		
586		D	RESISTOR		R553	1-247-855-91	RES-CF 1/4W J 10K -AT- SMALL	4050510355		
587		D	RESISTOR		R554	1-247-847-91	RES-CF 1/4W J 4.7K -AT- SMALL	4050547255		
588		D	RESISTOR		R555	1-247-855-91	RES-CF 1/4W J 10K -AT- SMALL	4050510355		
589		D	RESISTOR		R556	1-247-879-91	RES-CF 1/4W J 100K -AT- SMALL	4050510455		



No.	#	Board	Type	△/*	Ref.No.	Part No.	Description	Remarks-1	Remarks-2	Difference
590		D	RESISTOR		R557	1-216-857-81	RES-MOF 2W J 10R -SF-	4172010053		
591		D	RESISTOR		R558	1-247-865-91	RES-CF 1/4W J 27K -AT- SMALL	4050527355		
592		D	RESISTOR		R559	1-247-847-91	RES-CF 1/4W J 4.7K -AT- SMALL	4050547255		
593		D	RESISTOR		R560	1-247-855-91	RES-CF 1/4W J 10K -AT- SMALL	4050510355		
594		D	RESISTOR		R562	1-247-791-91	RES-CF 1/4W J 22R SMALL -AT-	4050522055		
595		D	RESISTOR		R563	1-247-879-91	RES-CF 1/4W J 100K -AT- SMALL	4050510455		
596		D	RESISTOR		R565	1-247-831-91	RES-CF 1/4W J 1K -AT- SMALL	4050510255		
597		D	RESISTOR		R567	1-242-998-11	RES-CF 1/4W J 10K NON-FLAME -S	4050510353		
598		D	RESISTOR		R568	1-247-839-91	RES-CF 1/4W J 2.2K -AT- SMALL	4050522255		
599		D	RESISTOR		R570	1-215-910-81	RES-MOF 3W J68R -SF- SMALL	4177368053		
600		D	RESISTOR		R571	1-247-859-91	RES-CF 1/4W J 15K -AT- SMALL	4050515355		
601		D	RESISTOR		R572	1-247-783-91	RES-CF 1/4W J 10R -AT- SMALL	4050510055		
602		D	RESISTOR		R574	1-247-868-91	RES-CF 1/4W J 36K -AT- SMALL	4050536355		
603		D	RESISTOR		R575	1-247-843-91	RES-CF 1/4W J 3.3K -AT- SMALL	4050533255		
604		D	RESISTOR		R576	1-242-973-11	RES-MOF 3W J 30K SMALL-	4177330355		
605		D	RESISTOR		R577	1-247-802-91	RES-CF 1/4W J 62R SMALL -AT-	4050562055		
606		D	RESISTOR		R578	1-247-900-91	RES-CF 1/4W J 750K SMALL -AT-	4050575455		
607		D	RESISTOR		R579	1-215-882-81	RES-MOF 2W J 22R-SF-	4172022053		
608		D	RESISTOR		R580	1-247-807-91	RES-CF 1/4W J 100R -AT- SMALL	4050510155		
609		D	RESISTOR		R581	1-215-910-81	RES-MOF 3W J68R -SF- SMALL	4177368053		
610		D	RESISTOR		R582	1-247-833-11	RES-CF 1/4W J 1.2K -AT- SMALL	4050512255		
611		D	RESISTOR		R583	1-216-375-81	RES-MOF 2W J 3.3R -SF-	4172033953		
612		D	RESISTOR		R587	1-247-775-91	RES-CF 1/4W J 4.7R SMALL NON-F	4050647952		
613		D	RESISTOR		R589	1-247-858-91	RES-CF 1/4W J 13K SMALL -AT-	4050513355		
614		D	RESISTOR		R590	1-215-493-91	RES-PR MF 1/4W F 1M SMALL -AT-	4257041004		
615		D	RESISTOR		R592	1-247-873-91	RES-CF 1/4W J 56K SMALL -AT-	4050556355		
616		D	RESISTOR		R593	1-247-831-91	RES-CF 1/4W J 1K -AT- SMALL	4050510255		
617		D	RESISTOR		R594	1-247-903-91	RES-CF 1/4W J 1M -AT- SMALL	4050510555		
618		D	RESISTOR		R595	1-247-879-91	RES-CF 1/4W J 100K -AT- SMALL	4050510455		
619		D	RESISTOR	△	R596	1-242-993-11	RES-PR MF 1/4W F 523K SMALL	4257045233		FOR MATSUSHITA FBT
620		D	RESISTOR	△	R596	1-242-992-11	RES-PR MF 1/4W F 475K SMALL -A	4257044753		FOR SAMPO FBT

No.	#	Board	Type	△/*	Ref.No.	Part No.	Description	Remarks-1	Remarks-2	Difference
621		D	RESISTOR		R598	1-240-906-11	RES-PR MF 1/4W F 24.3K SMALL -	4257042432		
622		D	RESISTOR		R599	1-242-986-11	RES-PR MF 1/4W F 4.32K SMALL -	4257044321		
623		D	RESISTOR		R5A0	1-243-676-11	RES-PR MF 1/2W F 90.9K SMALL -	4257029092		
624		D	RESISTOR		R5A1	1-247-855-91	RES-CF 1/4W J 10K -AT- SMALL	4050510355		
625		D	RESISTOR		R5A2	1-247-859-91	RES-CF 1/4W J 15K -AT- SMALL	4050515355		
626		D	RESISTOR		R5A3	1-260-135-91	RES-CF 1/2WSS J 1M-AT-W=52mm	4050110555		
627		D	RESISTOR		R5A5	1-247-823-91	RES-CF 1/4W J 470R SMALL -AT-	4050547155		
628		D	RESISTOR		R5A6	1-247-844-91	RES-CF 1/4W J 3.6K SMALL -AT-	4050536255		
629		D	RESISTOR		R5A8	1-216-341-81	RES-MOF 1W J 0.22R -SF-	4171022858		
630		D	RESISTOR		R5A9	1-216-375-81	RES-MOF 2W J 3.3R -IB-	4172033955		
631		D	RESISTOR		R5B0	1-247-876-91	RES-CF 1/4W J 75K SMALL -AT-	4050575355		
632		D	RESISTOR		R5B1	1-242-968-11	RES-CF 1/2WSS J 3.6K -AT-W=52	4050136255		
633		D	RESISTOR		R5B2	1-247-855-91	RES-CF 1/4W J 10K -AT- SMALL	4050510355		
634		D	RESISTOR		R5C0	1-247-881-91	RES-CF 1/4W J 120K -AT- SMALL	4050512455		
635		D	RESISTOR		R5C4	1-242-991-11	RES-PR MF 1/4W F 54.9K SMALL -	4257045492		
636		D	RESISTOR		R5C5	1-247-847-91	RES-CF 1/4W J 4.7K -AT- SMALL	4050547255		
637		D	RESISTOR		R5C6	1-247-807-91	RES-CF 1/4W J 100R -AT- SMALL	4050510155		
638		D	RESISTOR		R5C7	1-260-089-11	RES-CF 1/2WSS J 150R -AT-W=52	4050115155		
639		D	RESISTOR		R5E6	1-247-876-91	RES-CF 1/4W J 75K SMALL -AT-	4050575355		
640		D	RESISTOR		R5E7	1-247-872-91	RES-CF 1/4W J 51K -AT- SMALL	4050551355		
641		D	RESISTOR		R5E8	1-243-486-11	RES-CF 1/4W J 910R -AT- SMALL	4050591155		
642		D	RESISTOR		R5E9	1-247-807-91	RES-CF 1/4W J 100R -AT- SMALL	4050510155		
643		D	RESISTOR		R5F1	1-247-855-91	RES-CF 1/4W J 10K -AT- SMALL	4050510355		
644		D	RESISTOR		R5F2	1-216-423-81	RES-MOF 1W J 27R -SF-	4171027053		
645		D	RESISTOR		R5F3	1-247-767-91	RES-CF 1/4W J 2.2R SMALL -AT-	4050522955		
646		D	RESISTOR		R5F4	1-247-822-91	RES-CF 1/4W J 430R -AT- SMALL	4050543155		
647		D	RESISTOR		R5F5	1-247-823-91	RES-CF 1/4W J 470R SMALL -AT-	4050547155		
648		D	RESISTOR		R5F6	1-260-068-91	RES-CF 1/2WSS J 2.2R -AT-W=52	4050122955		
649		D	RESISTOR		R5F7	1-243-480-11	RES-CF 1/4W J 300R SMALL -AT-	4050530155		
650		D	RESISTOR		R5H1	1-247-855-91	RES-CF 1/4W J 10K -AT- SMALL	4050510355		
651		D	RESISTOR		R5H3	1-243-649-11	RES-MOF 3W J 6.8R SMALL -SF-	4177368953		

No.	#	Board	Type	△/*	Ref.No.	Part No.	Description	Remarks-1	Remarks-2	Difference
652		D	RESISTOR		R5H4	1-247-807-91	RES-CF 1/4W J 100R -AT- SMALL	4050510155		
653		D	RESISTOR		R5K1	1-243-652-11	RES-PR MF 1/4W F 5.62K SMALL -	4257045621		FOR MATSUSHITA FBT
654		D	RESISTOR		R5K1	1-240-901-11	RES-PR MF 1/4W F 9.31K SMALL -	4257049311		FOR SAMPO FBT
655		D	RESISTOR		R5K2	1-247-862-91	RES-CF 1/4W J 20K -AT- SMALL	4050520355		
656		D	RESISTOR		R5K3	1-240-902-11	RES-PR MF 1/4W F 10K AT SMALL	4257041002		
657		D	RESISTOR	△	R601	1-260-132-11	RES-CF 1/2WSS J 560K -AT-W=52	4050156455		
658		D	RESISTOR		R603	1-243-658-11	RES-MOF 3W J 22K SMALL -IB-	4177322355		
659		D	RESISTOR		R605	1-242-974-11	RES-MOF 2W J 30K SMALL -IB-	4177230355		
660		D	RESISTOR		R609	1-247-841-91	RES-CF 1/4W J 2.7K -AT- SMALL	4050527255		
661		D	RESISTOR		R610	1-247-783-91	RES-CF 1/4W J 10R -AT- SMALL	4050510055		
662		D	RESISTOR		R611	1-247-789-91	RES-CF 1/4W J 18R -AT- SMALL	4050518055		
663		D	RESISTOR		R612	1-242-989-11	RES-PR MF 1/4W F 7.15K SMALL -	4257047151		
664		D	RESISTOR		R614	1-216-361-81	RES-MOF 2W J 0.22R -IB-	4172022855		
665		D	RESISTOR		R615	1-247-831-91	RES-CF 1/4W J 1K -AT- SMALL	4050510255		
666		D	RESISTOR		R616	1-247-841-91	RES-CF 1/4W J 2.7K -AT- SMALL	4050527255		
667		D	RESISTOR		R617	1-227-183-11	RES-MG 1/2W J 560K -AT-	4160256455		
668		D	RESISTOR		R618	1-247-855-91	RES-CF 1/4W J 10K -AT- SMALL	4050510355		
669		D	RESISTOR		R619	1-247-855-91	RES-CF 1/4W J 10K -AT- SMALL	4050510355		
670		D	RESISTOR		R620	1-247-831-91	RES-CF 1/4W J 1K -AT- SMALL	4050510255		
671		D	RESISTOR		R621	1-247-815-91	RES-CF 1/4W J 220R SMALL -AT-	4050522155		
672		D	RESISTOR		R622	1-247-815-91	RES-CF 1/4W J 220R SMALL -AT-	4050522155		
673		D	RESISTOR		R623	1-247-807-91	RES-CF 1/4W J 100R -AT- SMALL	4050510155		
674		D	RESISTOR		R624	1-247-854-91	RES-CF 1/4W J 9.1K SMALL -AT-	4050591255		
675		D	RESISTOR		R625	1-247-855-91	RES-CF 1/4W J 10K -AT- SMALL	4050510355		
676		D	RESISTOR		R626	1-247-859-91	RES-CF 1/4W J 15K -AT- SMALL	4050515355		
677		D	RESISTOR		R627	1-242-990-11	RES-PR MF 1/4W F 7.32K SMALL -	4257047321		
678		D	RESISTOR		R628	1-247-802-91	RES-CF 1/4W J 62R SMALL -AT-	4050562055		
679		D	RESISTOR		R629	1-247-831-91	RES-CF 1/4W J 1K -AT- SMALL	4050510255		
680		D	RESISTOR		R630	1-247-845-91	RES-CF 1/4W J 3.9K -AT- SMALL	4050539255		
681		D	RESISTOR		R631	1-243-655-11	RES-CF 1/4W J 150R SMALL -AT-	4050515155		
682		D	RESISTOR	△	R632	1-260-132-11	RES-CF 1/2WSS J560K -AT-W=52mm	4050156456		

No.	#	Board	Type	△/*	Ref.No.	Part No.	Description	Remarks-1	Remarks-2	Difference
683		D	RESISTOR		R633	1-247-828-91	RES-CF 1/4W J 750R SMALL -AT-	4050575155		
684		D	RESISTOR		R634	1-247-795-91	RES-CF 1/4W J 33R -AT- SMALL	4050533055		
685		D	RESISTOR		R636	Pending	RES-PR MF 1/4W F 243K-AT-	4257042433		HMA-220
686		D	RESISTOR		R637	Pending	RES-PR MF 1/4W F 243K-AT-	4257042433		HMA-220
687		D	RESISTOR		R638	1-243-485-11	RES-CF 1/4W J 820K SMALL -AT-	4050582455		
688		D	RESISTOR		R639	1-243-485-11	RES-CF 1/4W J 820K SMALL -AT-	4050582455		
689		D	RESISTOR		R640	1-247-823-91	RES-CF 1/4W J 470R SMALL -AT-	4050547155		
690		D	RESISTOR		R641	1-247-823-91	RES-CF 1/4W J 470R SMALL -AT-	4050547155		
691		D	RESISTOR		R642	1-247-815-91	RES-CF 1/4W J 220R SMALL -AT-	4050522155		
692		D	RESISTOR		R643	1-240-908-11	RES-PR MF 1/4W F 88.7K SMALL -	4257048872		
693		D	RESISTOR		R644	1-242-985-11	RES-PR MF 1/4W F 2.87K SMALL -	4257042871		
694		D	RESISTOR		R650	1-260-089-11	RES-CF 1/2WSS J 150R -AT-W=52	4050115155		
695		D	RESISTOR		R651	1-247-855-91	RES-CF 1/4W J 10K -AT- SMALL	4050510355		
696		D	RESISTOR		R652	1-243-480-11	RES-CF 1/4W J 300R SMALL -AT-	4050530155		
697		D	RESISTOR		R653	1-215-888-71	RES-MOF 2W J 220R -IB- L=83	4172022155		
698		D	RESISTOR		R654	1-247-838-91	RES-CF 1/4W J 2K -AT- SMALL	4050520255		
699		D	RESISTOR		R655	1-247-836-91	RES-CF 1/4W J 1.6K -AT- SMALL	4050516255		
700		D	RESISTOR		R656	1-247-855-91	RES-CF 1/4W J 10K -AT- SMALL	4050510355		
701		D	RESISTOR		R657	1-243-648-11	RES-MOF 1W J 2.7R -SF-	4177127953		
702		D	RESISTOR		R658	1-247-855-91	RES-CF 1/4W J 10K -AT- SMALL	4050510355		
703		D	RESISTOR		R659	1-215-446-91	RES-PR MF 1/4W F 11K AT SMALL	4257041102		HMD-A220
704		D	RESISTOR		R665	1-247-855-91	RES-CF 1/4W J 10K -AT- SMALL	4050510355		
705		D	RESISTOR		R666	1-247-835-91	RES-CF 1/4W J 1.5K SMALL -AT-	4050515255		
706		D	RESISTOR		R668	1-243-036-11	RES-FUSIBLE 1W J 0.82R -SF- P	4181082853		
707		D	RESISTOR		R669	1-217-418-61	RES-FUSIBLE 1/2W K 0.47R -AT-	41802478A5		
708		D	RESISTOR		R670	1-260-089-11	RES-CF 1/2WSS J 150R -AT-W=52	4050115155		
709		D	RESISTOR		R671	1-247-855-91	RES-CF 1/4W J 10K -AT- SMALL	4050510355		
710		D	RESISTOR		R672	1-247-903-91	RES-CF 1/4W J 1M -AT- SMALL	4050510555		
711		D	RESISTOR		R673	1-247-871-91	RES-CF 1/4W J 47K -AT- SMALL	4050547355		
712		D	RESISTOR		R678	1-247-868-91	RES-CF 1/4W J 36K -AT- SMALL	4050536355		
713		D	RESISTOR		R679	1-216-379-81	RES-MOF 2W J 6.8K -SF-	4172068253		

No.	#	Board	Type	△/*	Ref.No.	Part No.	Description	Remarks-1	Remarks-2	Difference
714		D	RESISTOR		R680	1-247-844-91	RES-CF 1/4W J 3.6K SMALL -AT-	4050536255		
715		D	RESISTOR		R681	1-247-848-91	RES-CF 1/4W J 5.1K -AT- SMALL	4050551255		
716		D	RESISTOR		R682	1-243-645-11	RES-CF 1/4W J 200R -AT- SMALL	4050520155		
717		D	RESISTOR		R683	1-247-890-11	RES-CF 1/4W J 300K SMALL -AT-	4050530455		
718		D	RESISTOR		R684	1-247-789-91	RES-CF 1/4W J 18R -AT- SMALL	4050518055		
719		D	RESISTOR		R685	1-247-789-91	RES-CF 1/4W J 18R -AT- SMALL	4050518055		
720		D	RESISTOR		R686	1-243-643-11	RES-CF 1/4W J 1R SMALL -AT-	4050510955		
721		D	RESISTOR		R7A1	1-247-879-91	RES-CF 1/4W J 100K -AT- SMALL	4050510455		
722		D	RESISTOR		R7A2	1-247-879-91	RES-CF 1/4W J 100K -AT- SMALL	4050510455		
723		D	RESISTOR		R7A4	1-247-855-91	RES-CF 1/4W J 10K -AT- SMALL	4050510355		
724		D	RESISTOR		R7A5	1-247-855-91	RES-CF 1/4W J 10K -AT- SMALL	4050510355		
725		D	RESISTOR		R7B3	1-247-903-91	RES-CF 1/4W J 1M -AT- SMALL	4050510555		
726		D	RESISTOR		R7B4	1-247-903-91	RES-CF 1/4W J 1M -AT- SMALL	4050510555		
727		D	RESISTOR		R7C4	1-247-789-91	RES-CF 1/4W J 18R -AT- SMALL	4050518055		
728		D	RESISTOR		R7C5	1-247-789-91	RES-CF 1/4W J 18R -AT- SMALL	4050518055		
729		D	RESISTOR		R7C8	1-247-843-91	RES-CF 1/4W J 3.3K -AT- SMALL	4050533255		
730		D	RESISTOR		R7D4	1-247-903-91	RES-CF 1/4W J 1M -AT- SMALL	4050510555		
731		D	RESISTOR		R7D5	1-247-835-91	RES-CF 1/4W J 1.5K SMALL -AT-	4050515255		
732		D	RESISTOR		R7D6	1-247-855-91	RES-CF 1/4W J 10K -AT- SMALL	4050510355		
733		D	RESISTOR		R7D7	1-247-855-91	RES-CF 1/4W J 10K -AT- SMALL	4050510355		
734		D	RESISTOR		R7D8	1-247-831-91	RES-CF 1/4W J 1K -AT- SMALL	4050510255		
735		D	RESISTOR		R7D9	1-247-831-91	RES-CF 1/4W J 1K -AT- SMALL	4050510255		
736		D	RESISTOR		R7E1	1-247-831-91	RES-CF 1/4W J 1K -AT- SMALL	4050510255		
737		D	RESISTOR		R7E2	1-247-831-91	RES-CF 1/4W J 1K -AT- SMALL	4050510255		
738		D	RESISTOR		R7E3	1-247-855-91	RES-CF 1/4W J 10K -AT- SMALL	4050510355		
739		D	RESISTOR		R7E5	1-247-855-91	RES-CF 1/4W J 10K -AT- SMALL	4050510355		
740		D	RESISTOR		R7E6	1-247-855-91	RES-CF 1/4W J 10K -AT- SMALL	4050510355		
741		D	RESISTOR		R7E7	1-247-855-91	RES-CF 1/4W J 10K -AT- SMALL	4050510355		
742		D	RESISTOR		R7H1	1-247-843-91	RES-CF 1/4W J 3.3K -AT- SMALL	4050533255		
743		D	RESISTOR		R90	1-247-807-91	RES-CF 1/4W J 100R -AT- SMALL	4050510155		
744		D	RESISTOR		R901	1-247-831-91	RES-CF 1/4W J 1K -AT- SMALL	4050510255		

No.	#	Board	Type	△/*	Ref.No.	Part No.	Description	Remarks-1	Remarks-2	Difference
745		D	RESISTOR		R907	1-247-831-91	RES-CF 1/4W J 1K -AT- SMALL	4050510255		
746		D	RESISTOR		R908	1-247-831-91	RES-CF 1/4W J 1K -AT- SMALL	4050510255		
747		D	RESISTOR		R910	1-247-855-91	RES-CF 1/4W J 10K -AT- SMALL	4050510355		
748		D	RESISTOR		R911	1-247-855-91	RES-CF 1/4W J 10K -AT- SMALL	4050510355		
749		D	RESISTOR		R915	1-240-898-11	RES-PR MF 1/4W F 5.11K AT SMAL	4257045111		
750		D	RESISTOR		R916	1-247-831-91	RES-CF 1/4W J 1K -AT- SMALL	4050510255		
751		D	RESISTOR		R917	1-240-890-11	RES-PR MF 1/4W F 1K AT SMALL	4257041001		
752		D	RESISTOR		R918	1-247-862-91	RES-CF 1/4W J 20K -AT- SMALL	4050520355		
753		D	RESISTOR		R921	1-247-823-91	RES-CF 1/4W J 470R SMALL -AT-	4050547155		
754		D	RESISTOR		R922	1-247-847-91	RES-CF 1/4W J 4.7K -AT- SMALL	4050547255		
755		D	RESISTOR		R923	1-247-791-91	RES-CF 1/4W J 22R SMALL -AT-	4050522055		
756		D	RESISTOR		R924	1-247-791-91	RES-CF 1/4W J 22R SMALL -AT-	4050522055		HMD-A200
757		D	RESISTOR		R925	1-247-791-91	RES-CF 1/4W J 22R SMALL -AT-	4050522055		
758		D	RESISTOR		R926	1-247-791-91	RES-CF 1/4W J 22R SMALL -AT-	4050522055		HMD-A200
759		D	RESISTOR		R927	1-247-903-91	RES-CF 1/4W J 1M -AT- SMALL	4050510555		
760		D	RESISTOR		R928	1-247-855-91	RES-CF 1/4W J 10K -AT- SMALL	4050510355		
761		D	RESISTOR		R929	1-247-855-91	RES-CF 1/4W J 10K -AT- SMALL	4050510355		
762		D	RESISTOR		R930	1-247-855-91	RES-CF 1/4W J 10K -AT- SMALL	4050510355		
763		D	RESISTOR		R933	1-247-855-91	RES-CF 1/4W J 10K -AT- SMALL	4050510355		
764		D	RESISTOR		R940	1-247-872-91	RES-CF 1/4W J 51K -AT- SMALL	4050551355		
765		D	RESISTOR		R941	1-247-896-91	RES-CF 1/4W J 510K SMALL -AT-	4050551455		
766		D	RESISTOR		R949	1-247-855-91	RES-CF 1/4W J 10K -AT- SMALL	4050510355		
767		D	RESISTOR		R955	1-247-847-91	RES-CF 1/4W J 4.7K -AT- SMALL	4050547255		
768		D	RESISTOR		R961	1-240-890-11	RES-PR MF 1/4W F 1K AT SMALL	4257041001		
769		D	RESISTOR		R963	1-247-840-91	RES-CF 1/4W J 2.4K SMALL -AT-	4050524255		
770		D	RESISTOR		R965	1-247-855-91	RES-CF 1/4W J 10K -AT- SMALL	4050510355		
771		D	RESISTOR		R967	1-247-853-91	RES-CF 1/4W J 8.2K -AT- SMALL	4050582255		
772		D	RESISTOR		R968	1-247-847-91	RES-CF 1/4W J 4.7K -AT- SMALL	4050547255		
773		D	RESISTOR		R969	1-247-831-91	RES-CF 1/4W J 1K -AT- SMALL	4050510255		
774		D	RESISTOR		R970	1-247-847-91	RES-CF 1/4W J 4.7K -AT- SMALL	4050547255		
775		D	RESISTOR		R971	1-242-983-11	RES-PR MF 1/4W F 2K AT SMALL	4257042001		

No.	#	Board	Type	△/*	Ref.No.	Part No.	Description	Remarks-1	Remarks-2	Difference
776		D	RESISTOR		R972	1-247-847-91	RES-CF 1/4W J 4.7K -AT- SMALL	4050547255		
777		D	RESISTOR		R973	1-247-831-91	RES-CF 1/4W J 1K -AT- SMALL	4050510255		
778		D	RESISTOR		R974	1-240-888-11	RES-PR MF 1/4W F 33.2R SMALL -	4257043329		
779		D	RESISTOR		R975	1-240-907-11	RES-PR MF 1/4W F 30.1K AT SMAL	4257043012		
780		D	RESISTOR		R976	1-247-831-91	RES-CF 1/4W J 1K -AT- SMALL	4050510255		
781		D	RESISTOR		R977	1-247-847-91	RES-CF 1/4W J 4.7K -AT- SMALL	4050547255		
782		D	SPARK GAP		SG501	1-519-422-21	SPARK GAP 1.2KV AG-15 P:5mm-RT	5106122204		
783		D	THERMISTOR	△	TH601	1-803-533-11	THMER. +-15% 10R 5A 15ÅEW/KINK	710501003B		
784		D	THERMISTOR	△	TH602	1-803-963-11	PTCR PTH451D480BF5M270D 4R5 +-	7106070027		
785		D	TRANSFORMER	△	T501	1-453-321-11	F.B.T.	7050307R50		
786		D	TRANSFORMER		T502	1-435-293-11	DRIVER TRANSFORMER	7050207R50		
787		D	TRANSFORMER		T503	1-433-799-11	TRANSDUCER CURRENT SENSOR	7177H10000		
788		D	TRANSFORMER		T504	1-435-294-11	FOCUS TRANSFORMER (DFT)	7050507C20		
789		D	TRANSFORMER		T601	1-437-516-11	HARMONIC COIL	7051307R61		HMD-A220
790		D	TRANSFORMER	△	T603	1-435-292-11	POWER TRANSFORMER	7050105R50		
791		D	TRANSISTOR		Q401	8-729-191-57	TRS. 2SC945P TO-92 -RT-	411020945P		
792		D	TRANSISTOR		Q501	8-729-027-83	TRS. MOSFET 2SJ307 TO-220FM	4101603070		
793		D	TRANSISTOR		Q502	8-729-051-33	TRS. FS10KM-6 TO-220FN	41035010K1		
794		D	TRANSISTOR		Q503	8-729-052-42	TRS. 2SC5587 TO-3P	4100255870		
795		D	TRANSISTOR		Q504	8-729-052-49	TRS. MOSFET FS10SM-16A TO-3P	41035016S0		
796		D	TRANSISTOR		Q505	8-729-191-57	TRS. 2SC945P TO-92 -RT-	411020945P		
797		D	TRANSISTOR		Q506	8-729-051-30	TRS. IRF634A TO-220	4105906340		
798		D	TRANSISTOR		Q507	8-729-051-30	TRS. IRF634A TO-220	4105906340		
799		D	TRANSISTOR		Q508	8-729-191-57	TRS. 2SC945P TO-92 -RT-	411020945P		
800		D	TRANSISTOR		Q509	8-729-191-57	TRS. 2SC945P TO-92 -RT-	411020945P		
801		D	TRANSISTOR		Q511	8-729-173-36	TRS. KSA733C-GTA TO-92 -RT-	4110007330		
802		D	TRANSISTOR		Q512	8-729-206-21	TRS. RN1203 -RT-	4116612030		
803		D	TRANSISTOR		Q513	8-729-173-36	TRS. KSA733C-GTA TO-92 -RT-	4110007330		
804		D	TRANSISTOR		Q514	8-729-173-36	TRS. KSA733C-GTA TO-92 -RT-	4110007330		
805		D	TRANSISTOR		Q515	8-729-191-57	TRS. 2SC945P TO-92 -RT-	411020945P		
806		D	TRANSISTOR		Q516	8-729-173-36	TRS. KSA733C-GTA TO-92 -RT-	4110007330		

No.	#	Board	Type	△/*	Ref.No.	Part No.	Description	Remarks-1	Remarks-2	Difference
807		D	TRANSISTOR		Q517	8-729-306-92	TRS. 2SD669A TO-126	410030669A		
808		D	TRANSISTOR		Q518	8-729-306-92	TRS.HSB649A(C)	410010649A		
809		D	TRANSISTOR		Q519	8-729-119-80	TRS. 2SC2688 TO-126	4100226880		
810		D	TRANSISTOR		Q520	8-729-191-57	TRS. 2SC945P TO-92 -RT-	411020945P		
811		D	TRANSISTOR		Q521	8-729-173-36	TRS. KSA733C-GTA TO-92 -RT-	4110007330		
812		D	TRANSISTOR		Q523	8-729-023-28	TRS. 2SD1640Q TO-126	4100316400		
813		D	TRANSISTOR		Q524	8-729-051-30	TRS. IRF634A TO-220	4105906340		
814		D	TRANSISTOR		Q526	8-729-206-21	TRS. RN1203 -RT-	4116612030		
815		D	TRANSISTOR		Q527	8-729-140-51	TRS. 2SC3209LK SP-8	410023209L		
816		D	TRANSISTOR		Q530	8-729-119-80	TRS. 2SC2688 TO-126	4100226880		
817		D	TRANSISTOR		Q531	8-729-051-31	TRS. KSP92 TO-92	4112409200		
818		D	TRANSISTOR		Q532	8-729-173-36	TRS. KSA733C-GTA TO-92 -RT-	4110007330		
819		D	TRANSISTOR		Q533	8-729-173-36	TRS. KSA733C-GTA TO-92 -RT-	4110007330		
820		D	TRANSISTOR		Q534	8-729-206-21	TRS. RN1203 -RT-	4116612030		
821		D	TRANSISTOR		Q535	8-729-052-08	TRS. RN1001 -RT-	4116610010		
822		D	TRANSISTOR		Q5E2	8-729-306-72	TRS. 2SD667A TO-92M -RT-	411030667A		
823		D	TRANSISTOR		Q5E3	8-729-300-72	TRS. 2SB647A(C) -RT-	411010647A		
824		D	TRANSISTOR		Q5H1	8-729-306-92	TRS. 2SD669A TO-126	410030669A		
825		D	TRANSISTOR		Q5H2	8-729-191-57	TRS. 2SC945P TO-92 -RT-	411020945P		
826		D	TRANSISTOR		Q5K1	8-729-191-57	TRS. 2SC945P TO-92 -RT-	411020945P		
827		D	TRANSISTOR		Q601	8-729-173-36	TRS. KSA733C-GTA TO-92 -RT-	4110007330		
828		D	TRANSISTOR		Q602	8-729-048-21	TRS. FS10KM-12 TO-220F	41035010K0		
829		D	TRANSISTOR		Q603	8-729-173-36	TRS. 2SA733 TO-92M -RT-	4110007330		HMD-A220
830		D	TRANSISTOR		Q607	8-729-200-35	TRS. 2SA966 TPE6 TO-92M -RT-	4110009660		
831		D	TRANSISTOR		Q608	8-729-052-08	TRS. RN1001 -RT-	4116610010		
832		D	TRANSISTOR		Q609	8-729-209-60	TRS. 2SB1375 TO-220	4100113750		
833		D	TRANSISTOR		Q610	8-729-206-21	TRS. RN1203 -RT-	4116612030		
834		D	TRANSISTOR		Q611	8-729-206-21	TRS. RN1203 -RT-	4116612030		
835		D	TRANSISTOR		Q615	8-729-191-57	TRS. 2SC945P TO-92 -RT-	411020945P		
836		D	TRANSISTOR		Q616	8-729-306-72	TRS. 2SD667A TO-92M -RT-	411030667A		
837		D	TRANSISTOR		Q908	8-729-139-04	TRS. 2N3904 TO-92 -RT-	4111139040		



No.	#	Board	Type	△/*	Ref.No.	Part No.	Description	Remarks-1	Remarks-2	Difference
838		D	VARIABLE RESISTOR	△	RV501	1-241-768-21	POT(CERMET) 0.3W 220K 6	5.2241E+11		
839		D	VARIABLE RESISTOR		RV502	1-241-775-21	POT(CERMET) 0.3W 22K 6	5.2241E+11		
840		D	VARISTOR		VA601	Pending	VARISTOR 275V 2322-595-2716	7112755950		
841		D	VARISTOR		VA603	Pending	VARISTOR 275V 2322-595-2716	7112755950		
842		D	VARISTOR		VA604	Pending	VARISTOR ERZV14D471	7112604710		HMD-A220
843		D	VARISTOR		VA605	Pending	VARISTOR 275V 2322-595-2716	7112755950		HMD-A220
844		H	LED		LED701	8-719-074-21	LED LT6463-23-D51 5ÅEG/Y	4120664630		
845		H	RESISTOR		R701	1-240-901-11	RES-PR MF 1/4W F 9.31K SMALL -	4257049311		
846		H	RESISTOR		R702	1-242-984-11	RES-PR MF 1/4W F 2.74K SMALL -	4257042741		
847		H	RESISTOR		R703	1-247-879-91	RES-CF 1/4W J 100K -AT- SMALL	4050510455		
848		H	RESISTOR		R704	1-247-879-91	RES-CF 1/4W J 100K -AT- SMALL	4050510455		
849		H	RESISTOR		R707	1-247-823-91	RES-CF 1/4W J 470R SMALL -AT-	4050547155		
850		H	RESISTOR		R708	1-247-823-91	RES-CF 1/4W J 470R SMALL -AT-	4050547155		
851		H	RESISTOR		R709	1-240-897-11	RES-PR MF 1/4W F 4.99K AT SMAL	4257044991		
852		H	SWITCH		SW701	1-771-734-11	TACT SWITCH SKQUCAA010	4410606000		
853		U1	CAPACITOR		C7A1	1-136-497-11	CAP-SCF 0.1UFZ 50V -RT-	5134104452		
854		U1	CAPACITOR		C7A4	1-136-497-11	CAP-SCF 0.1UFZ 50V -RT-	5134104452		
855		U1	CAPACITOR		C7B6	1-135-902-11	CAP-EC6 330UFM 10V -RT-	5153331T10		
856		U1	CAPACITOR		C7B8	1-135-902-11	CAP-EC6 330UFM 10V -RT-	5153331T10		
857		U1	FERRITE BEAD		L7F1	1-412-911-11	FERRITE BEAD 2.3UH	7099159250		
858		U1	FERRITE BEAD		L7F2	1-412-911-11	FERRITE BEAD 2.3UH	7099159250		
859		U1	FERRITE BEAD		L7F3	1-412-911-11	FERRITE BEAD 2.3UH	7099159250		
860		U1	FERRITE BEAD		L7F4	1-412-911-11	FERRITE BEAD 2.3UH	7099159250		
861		U1	RESISTOR		R7F4	1-243-646-11	RES-CF 1/4W J 24R SMALL -AT-	4050524055		
862		U1	RESISTOR		R7F5	1-243-646-11	RES-CF 1/4W J 24R SMALL -AT-	4050524055		
863		U1	RESISTOR		R7F6	1-243-646-11	RES-CF 1/4W J 24R SMALL -AT-	4050524055		
864		U1	RESISTOR		R7F7	1-243-646-11	RES-CF 1/4W J 24R SMALL -AT-	4050524055		
865		U2	CAPACITOR		C7A3	1-136-497-11	CAP-SCF 0.1UFZ 50V -RT-	5134104452		
866		U2	CAPACITOR		C7A6	1-136-497-11	CAP-SCF 0.1UFZ 50V -RT-	5134104452		
867		U2	CAPACITOR		C7B7	1-135-902-11	CAP-EC6 330UFM 10V -RT-	5153331T10		
868		U2	CAPACITOR		C7B9	1-135-902-11	CAP-EC6 330UFM 10V -RT-	5153331T10		

No.	#	Board	Type	△/*	Ref.No.	Part No.	Description	Remarks-1	Remarks-2	Difference
869		U2	FERRITE BEAD		L7G1	1-412-911-11	FERRITE BEAD 2.3UH	7099159250		
870		U2	FERRITE BEAD		L7G4	1-412-911-11	FERRITE BEAD 2.3UH	7099159250		
871		U2	FERRITE BEAD		L7G5	1-412-911-11	FERRITE BEAD 2.3UH	7099159250		
872		U2	FERRITE BEAD		L7G8	1-412-911-11	FERRITE BEAD 2.3UH	7099159250		
873		U2	RESISTOR		R7F1	1-243-646-11	RES-CF 1/4W J 24R SMALL -AT-	4050524055		
874		U2	RESISTOR		R7F2	1-243-646-11	RES-CF 1/4W J 24R SMALL -AT-	4050524055		
875		U2	RESISTOR		R7F3	1-243-646-11	RES-CF 1/4W J 24R SMALL -AT-	4050524055		
876		U2	RESISTOR		R7F8	1-243-646-11	RES-CF 1/4W J 24R SMALL -AT-	4050524055		

